

Regulation

# iSense Pro DIN - AD280

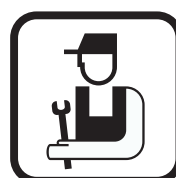
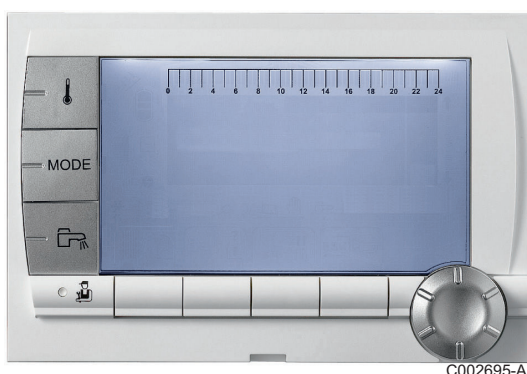

## Installation and Service Manual

# Contents

---

<b>1</b>	<b>Introduction .....</b>	<b>4</b>
	<b>1.1 Symbols used .....</b>	<b>4</b>
	<b>1.2 Abbreviations .....</b>	<b>4</b>
	<b>1.3 General .....</b>	<b>4</b>
	1.3.1 Manufacturer's liability .....	4
	1.3.2 Installer's liability .....	5
	<b>1.4 Certifications .....</b>	<b>5</b>
<b>2</b>	<b>Safety instructions and recommendations .....</b>	<b>6</b>
	<b>2.1 Recommendations .....</b>	<b>6</b>
<b>3</b>	<b>Technical description .....</b>	<b>7</b>
	<b>3.1 Description of the keys .....</b>	<b>7</b>
	<b>3.2 Description of the display .....</b>	<b>8</b>
	3.2.1 Key functions .....	8
	3.2.2 Flame symbol .....	8
	3.2.3 Operating modes .....	8
	3.2.4 Domestic Hot Water override .....	9
	3.2.5 Other information .....	9
	<b>3.3 Technical characteristics .....</b>	<b>9</b>
<b>4</b>	<b>Installation .....</b>	<b>11</b>
	<b>4.1 Package list .....</b>	<b>11</b>
	<b>4.2 Installing the outside sensor .....</b>	<b>11</b>
	4.2.1 Choice of the location .....	11
	4.2.2 Connecting the outside sensor .....	12
	<b>4.3 Mounting and connecting the module .....</b>	<b>13</b>
	4.3.1 Boiler GAS 210 ECO PRO .....	13
	4.3.2 Boiler GAS 310 ECO .....	14
	<b>4.4 Electrical connections .....</b>	<b>16</b>
	4.4.1 Recommendations .....	16
	4.4.2 Connecting a heating circuit .....	17
	4.4.3 Connecting a heating circuit and a domestic hot water tank .....	18
	4.4.4 Connecting two circuits and a domestic hot water tank .....	19
	4.4.5 Connecting a direct circuit, a valve circuit and a DHW tank .....	20
	4.4.6 Hot water storage tank connection .....	21

4.4.7	Pool connection .....	23
4.4.8	Connecting a mixed tank .....	25
4.4.9	Connecting the options .....	25
4.4.10	Connection in cascade .....	27
<b>5</b>	<b>Operating the appliance .....</b>	<b>30</b>
5.1	Powering up for the first time .....	30
5.2	Access to the various browsing levels .....	30
5.2.1	User level .....	30
5.2.2	Installer level .....	31
5.2.3	After Sales level .....	31
5.3	Browsing in the menus .....	31
5.4	Reading out measured values .....	32
5.5	Settings after powering up for the first time .....	33
5.5.1	Displaying the parameters in extended mode .....	33
5.5.2	Setting the parameters specific to the installation .....	34
5.5.3	Naming the circuits and generators .....	36
5.5.4	Setting the heating curve .....	37
5.6	Changing the settings .....	38
5.6.1	Language selection .....	39
5.6.2	Calibrating the sensors .....	39
5.6.3	Professional settings .....	40
5.6.4	Configuring the network .....	45
5.6.5	Return to the factory settings .....	52
<b>6</b>	<b>Switching off the appliance .....</b>	<b>53</b>
6.1	Installation shutdown .....	53
6.2	Frost protection .....	53
<b>7</b>	<b>Troubleshooting .....</b>	<b>54</b>
7.1	Installer's contact details .....	54
7.2	Messages .....	54
7.3	Message history .....	55
7.4	Faults .....	55
7.4.1	Deletion of sensors from the memory in the PCB .....	58
7.4.2	Deleting the IOBL 3WV modules from the memory in the PCB .....	58

<b>7.5</b>	<b>Failure history .....</b>	<b>59</b>
<b>7.6</b>	<b>Parameter and input/output check (mode tests) .....</b>	<b>59</b>

# 1 Introduction

---

## 1.1 Symbols used

---

In these instructions, various danger levels are employed to draw the user's attention to particular information. In so doing, we wish to safeguard the user's safety, obviate hazards and guarantee correct operation of the appliance.



### **DANGER**

Risk of a dangerous situation causing serious physical injury.



### **WARNING**

Risk of a dangerous situation causing slight physical injury.



### **CAUTION**

Risk of material damage.



Signals important information.



Signals a referral to other instructions or other pages in the instructions.

## 1.2 Abbreviations

---

- ▶ **DHW**: Domestic hot water
- ▶ **Interscenario switch**: Home automation switch that can be used to centralise and control several scenarios
- ▶ **IOBL**: Carrier current home automation bus
- ▶ **3WV**: 3-way valve

## 1.3 General

---

### 1.3.1. Manufacturer's liability

---

Our products are manufactured in compliance with the requirements of the various applicable European Directives. They are therefore delivered with  marking and all relevant documentation.

In the interest of customers, we are continuously endeavouring to make improvements in product quality. All the specifications stated in this document are therefore subject to change without notice.

Our liability as the manufacturer may not be invoked in the following cases:

- ▶ Failure to abide by the instructions on using the appliance.
- ▶ Faulty or insufficient maintenance of the appliance.
- ▶ Failure to abide by the instructions on installing the appliance.

### **1.3.2. Installer's liability**

---

The installer is responsible for the installation and initial start up of the appliance. The installer must respect the following instructions:

- ▶ Read and follow the instructions given in the manuals provided with the appliance.
- ▶ Carry out installation in compliance with the prevailing legislation and standards.
- ▶ Perform the initial start up and carry out any checks necessary.
- ▶ Explain the installation to the user.
- ▶ If a maintenance is necessary, warn the user of the obligation to check the appliance and maintain it in good working order.
- ▶ Give all the instruction manuals to the user.

## **1.4 Certifications**

---

This product complies to the requirements to the european directives and following standards:

- ▶ 2006/95/EC Low Voltage Directive. Reference Standard: EN60.335.1.
- ▶ 2004/108/EC Electromagnetic Compatibility Directive. Generic standards: EN1000-6-3 , EN 61000-6-1.

## 2 Safety instructions and recommendations

---

### 2.1 Recommendations

---

**WARNING**

Only qualified professionals are authorised to work on the appliance and the installation.

The appliance should be on Summer or Antrifreeze mode rather than switched off to guarantee the following functions:

- ▶ Anti blocking of pumps.
- ▶ Frost protection.

# 3 Technical description

## 3.1 Description of the keys

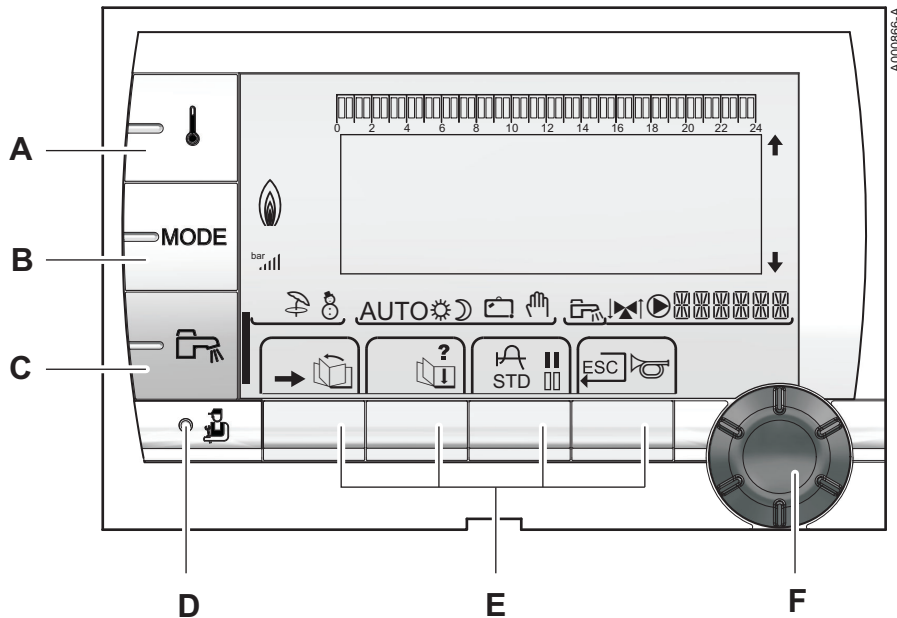

- A** Temperature setting key (heating, DHW, swimming pool)
- B** Operating mode selection key
- C** DHW override key
- D** Key to access the parameters reserved for the installer
- E** Keys on which the function varies as and when selections are made
- F** Rotary setting button:
  - ▶ Turn the rotary button to scroll through the menus or modify a value
  - ▶ Press the rotary button to access the menu selected or confirm a value modification



## 3.2 Description of the display

### 3.2.1. Key functions

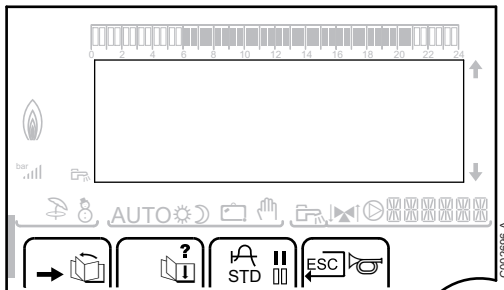

- Access to the various menus
- Used to scroll through the menus
- Used to scroll through the parameters
- ? The symbol is displayed when help is available
- Used to display the curve of the parameter selected
- STD** Reset of the time programmes
- Selection of comfort mode or selection of the days to be programmed
- Selection of reduced mode or deselection of the days to be programmed
- Back to the previous level
- ESC** Back to the previous level without saving the modifications made

### 3.2.2. Flame symbol

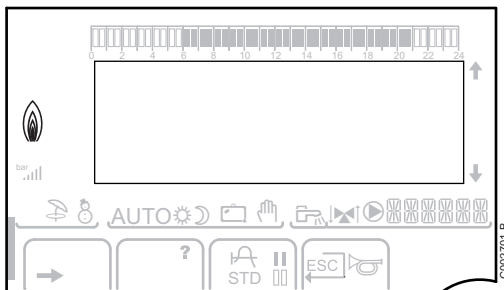

- ▶ The symbol is displayed: The burner is operating.
- ▶ The symbol is not displayed: The burner is off.

### 3.2.3. Operating modes

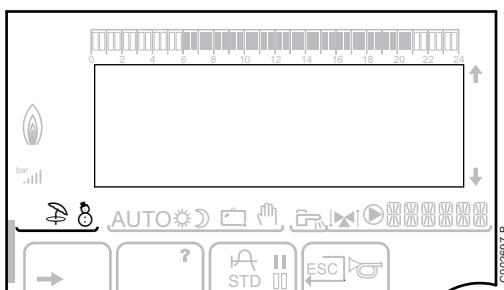

- Summer mode: The heating is off. Domestic hot water continues to be produced
- WINTER mode: Heating and domestic hot water working

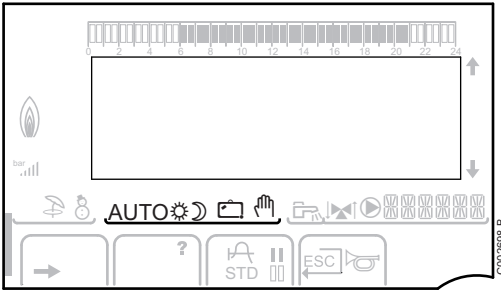

- AUTO** Operation in automatic mode according to the timer programme
- Comfort mode: The symbol is displayed when a DAY override (comfort) is activated
  - ▶ Flashing symbol: Temporary override
  - ▶ Steady symbol: Permanent override
- Reduced mode: The symbol is displayed when a NIGHT override (reduced) is activated
  - ▶ Flashing symbol: Temporary override
  - ▶ Steady symbol: Permanent override
- Holiday mode: The symbol is displayed when a HOLIDAY override (antifreeze) is activated
  - ▶ Flashing symbol: Holiday mode programmed
  - ▶ Steady symbol: Holiday mode active
- Manual mode

### 3.2.4. Domestic Hot Water override

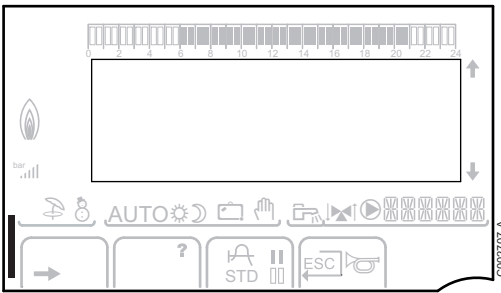

- A bar is displayed when a DHW override is activated:
- ▶ Flashing bar: Temporary override
  - ▶ Steady bar: Permanent override

### 3.2.5. Other information

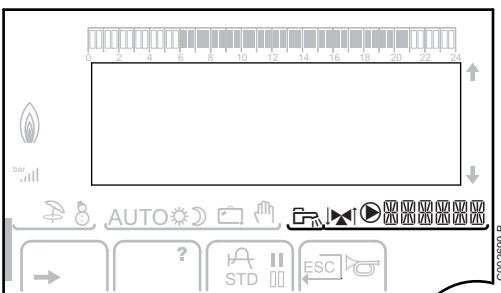

- The symbol is displayed when domestic hot water production is running
- Valve indicator: The symbol is displayed when a 3-way valve is connected
  - ▶ : 3-way valve open
  - ▶ : 3-way valve closed
- The symbol is displayed when the pump is operating
- Name of the circuit for which the parameters are displayed

## 3.3 Technical characteristics

Electricity supply: 230 V - 50 Hz

Outside sensor		Outlet sensor circuit B+C Domestic hot water sensor System sensor	
-20 °C	2392 Ω	0 °C	32014 Ω
-16 °C	2088 Ω	10 °C	19691 Ω
-12 °C	1811 Ω	20 °C	12474 Ω
-8 °C	1562 Ω	25 °C	10000 Ω
-4 °C	1342 Ω	30 °C	8080 Ω
0 °C	1149 Ω	40 °C	5372 Ω
4 °C	984 Ω	50 °C	3661 Ω
8 °C	842 Ω	60 °C	2535 Ω
12 °C	720 Ω	70 °C	1794 Ω
16 °C	616 Ω	80 °C	1290 Ω
20 °C	528 Ω	90 °C	941 Ω
24 °C	454 Ω		

# 4 Installation

---

## 4.1 Package list

---

The delivery includes:

- ▶ The iSense Pro DIN module
- ▶ Electrical harness
- ▶ Extension cable marked K1 (For connecting a GAS 210 ECO PRO boiler)
- ▶ Outside sensor
- ▶ Flow sensor (x2)
- ▶ DHW sensor
- ▶ Earth terminal block + 2 screws
- ▶ Installation and Service Manual
- ▶ User Guide.

## 4.2 Installing the outside sensor

---

### 4.2.1. Choice of the location

---

It is important to select a place that allows the sensor to measure the outside conditions correctly and effectively.

**Advised positions:**

- ▶ on one face of the area to be heated, on the north if possible
- ▶ half way up the wall in the room to be heated
- ▶ under the influence of meteorological variations
- ▶ protected from direct sunlight
- ▶ easy to access

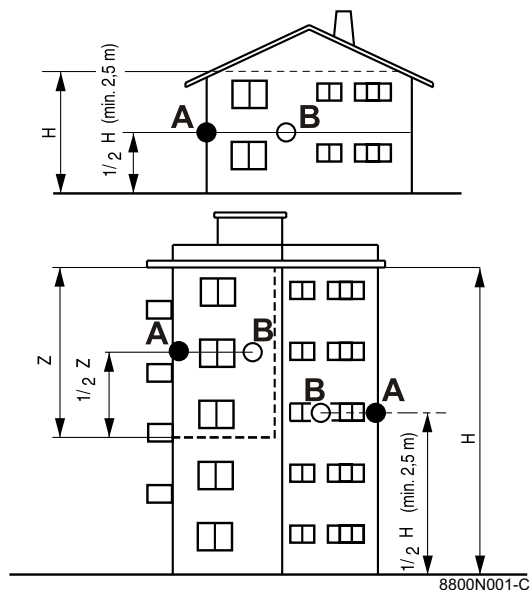

- A** Recommended position
- B** Possible position
- H** Inhabited height controlled by the sensor
- Z** Inhabited area controlled by the sensor

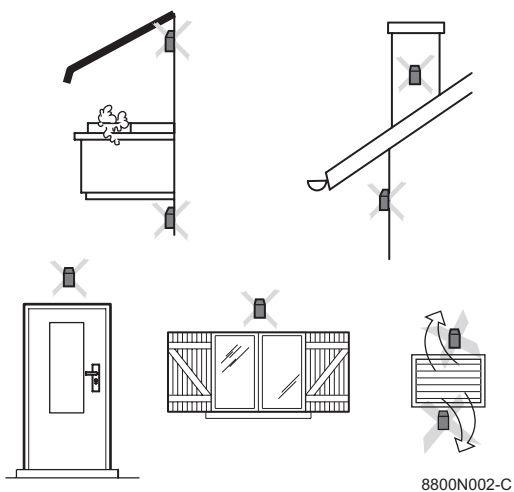

**Positions to be avoided:**

- ▶ masked by a building element (balcony, roof, etc.)
- ▶ close to a disruptive heat source (sun, chimney, ventilation grid, etc.)

**4.2.2. Connecting the outside sensor**

Mount the sensor using the screws and dowels provided.

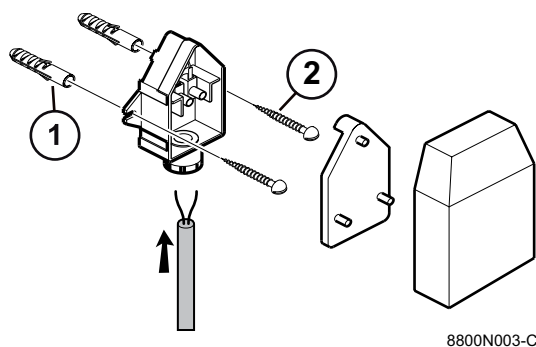

- ① Inserts
- ② Ø4 wood screw

### 4.3 Mounting and connecting the module

#### 4.3.1. Boiler GAS 210 ECO PRO

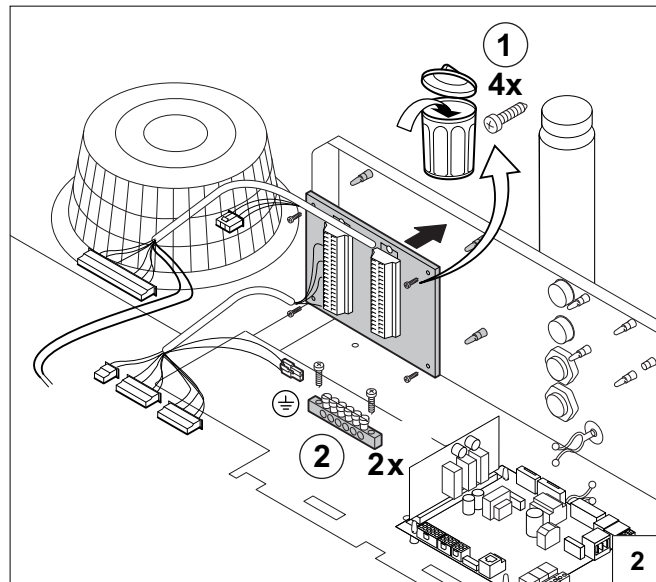
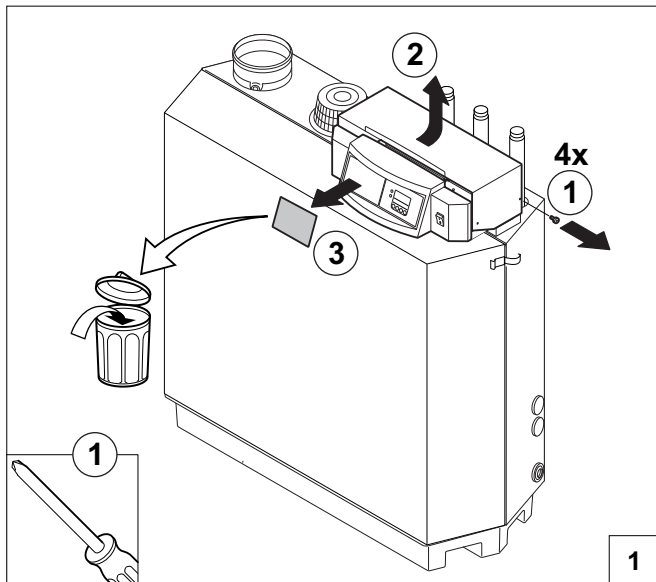

C003311-B

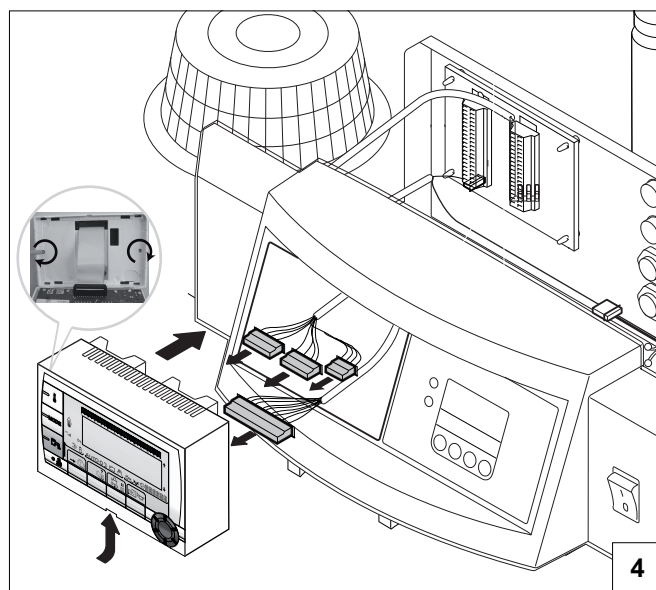
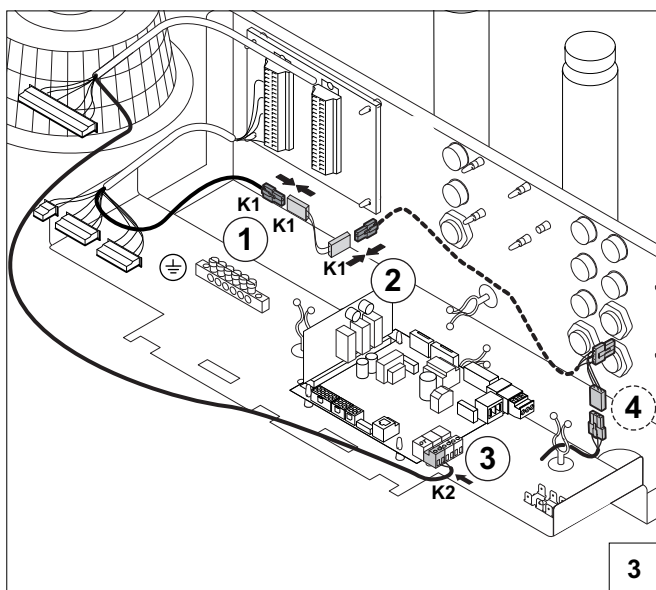

C003312-B



**CAUTION**

**Step 3:** Connect the extension cable **K1** between connectors ① and ②.



### 4.3.2. Boiler GAS 310 ECO



C003313-A

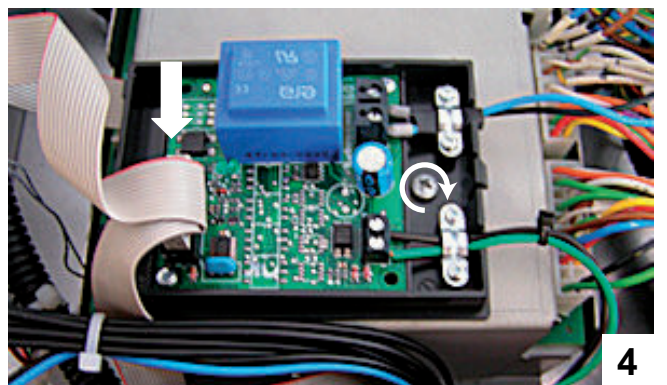
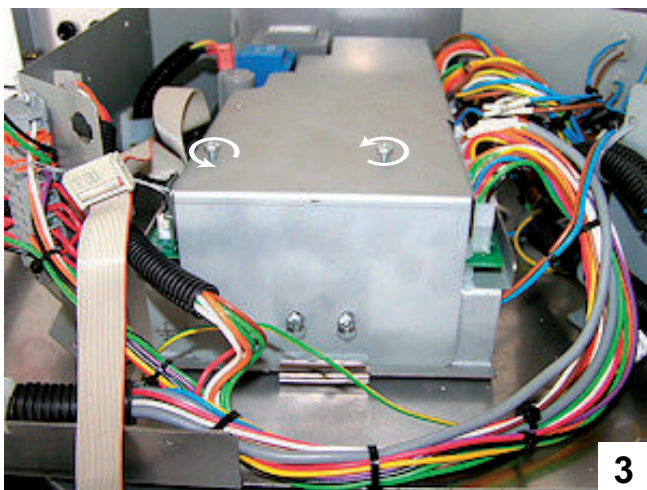

C003314-B

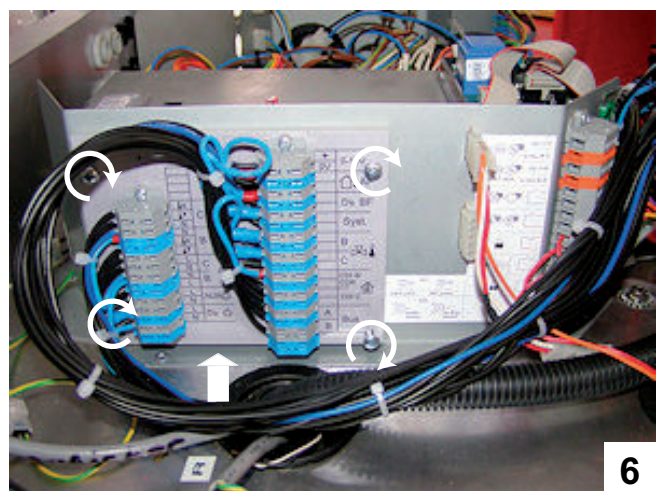

C003315-A

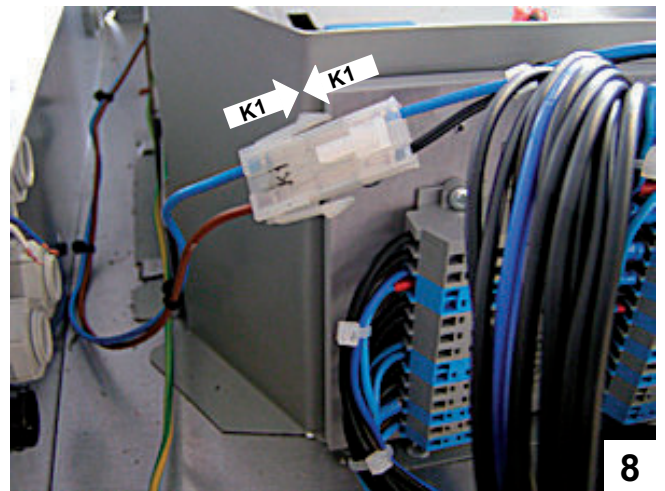
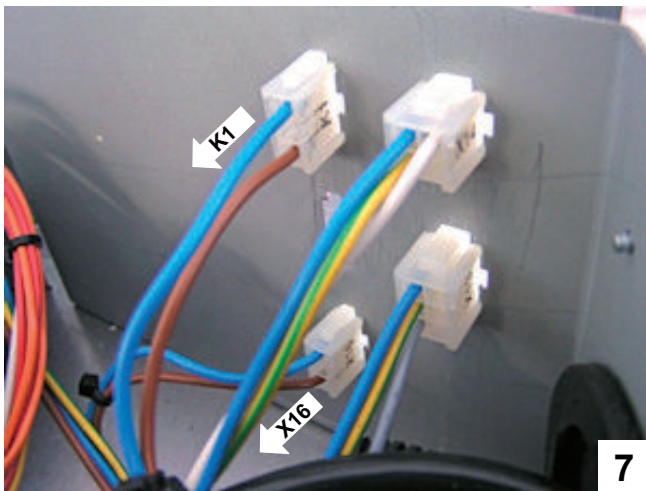

C003316-A

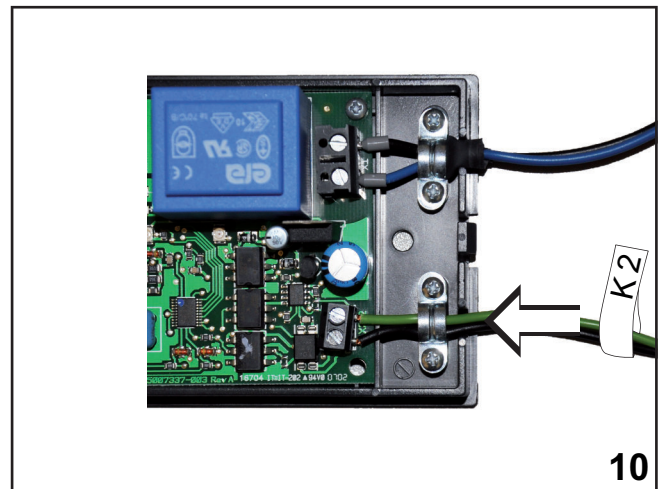
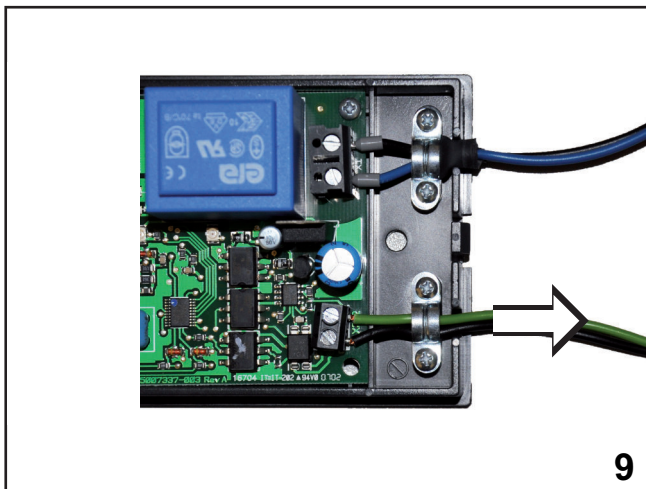

C003317-C

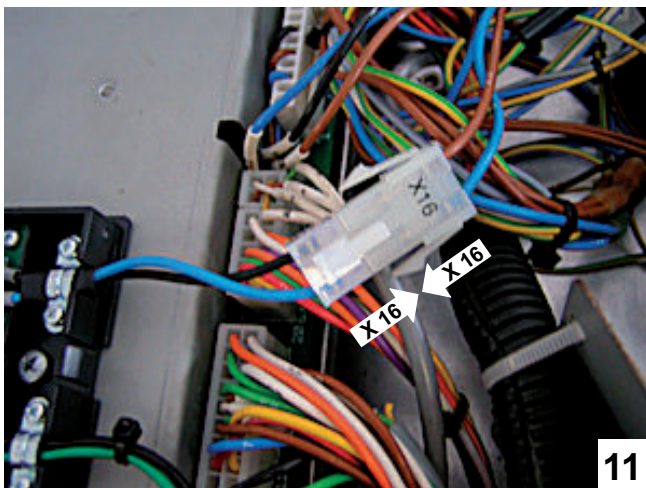

C003318-B





13

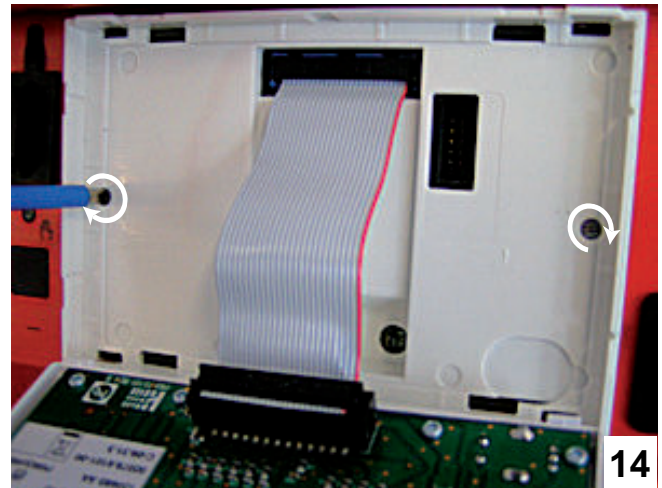

14

C003319-B

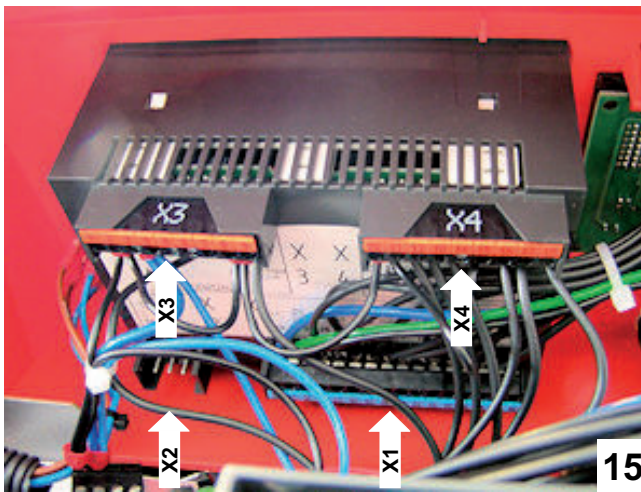

15



16

C003320-B

## 4.4 Electrical connections

### 4.4.1. Recommendations



#### WARNING

- ▶ Only qualified professionals may carry out electrical connections, always with the power off.
- ▶ The boiler is entirely pre-wired. Do not modify the connections inside the control panel.
- ▶ Earth the appliance before making any electrical connections.

Make the electrical connections of the boiler according to:

- ▶ The instructions of the prevailing standards.
- ▶ The instructions on the electrical diagrams provided with the boiler.
- ▶ The recommendations in the instructions.



#### CAUTION

Separate the sensor cables from the 230 V cables.

### 4.4.2. Connecting a heating circuit

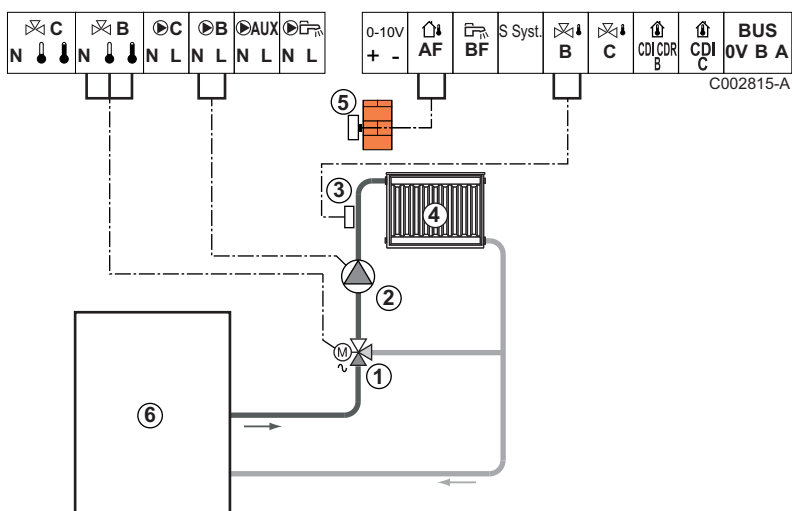

- ① 3 way valve circuit B
- ② Heating pump circuit B
- ③ Outlet sensor circuit B
- ④ Heating circuit B
- ⑤ Outside sensor
- ⑥ Boiler



Earth the various pumps and 3-way valves.

Settings to be made for this type of installation			
Parameters	Access	Settings to be made	See chapter
<b>CIRC.CURVE B</b>	Installer level #SECONDARY INSTAL.P menu	To be customised	"Setting the heating curve", page 37
<b>MAX. CIRC. B</b>	Installer level #SECONDARY LIMITS menu	To be customised	"Professional settings", page 40

### 4.4.3. Connecting a heating circuit and a domestic hot water tank

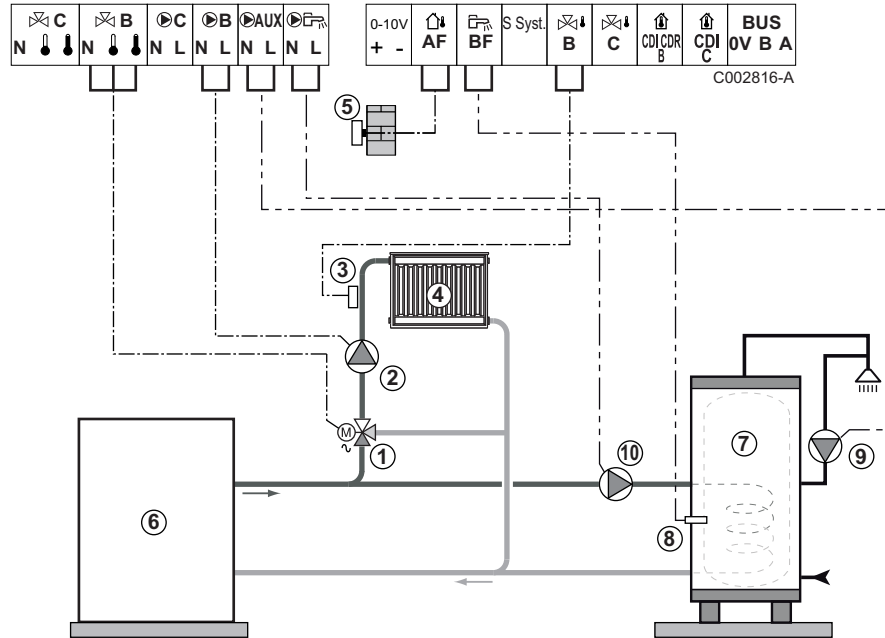

- ① 3 way valve circuit B
- ② Heating pump circuit B
- ③ Outlet sensor circuit B
- ④ Heating circuit B
- ⑤ Outside sensor
- ⑥ Boiler
- ⑦ DHW storage tank
- ⑧ DHW sensor
- ⑨ Domestic circulation loop pump (Optional)
- ⑩ D.H.W. load pump



Earth the various pumps and 3-way valves.

Settings to be made for this type of installation			
Parameters	Access	Settings to be made	See chapter
CIRC.CURVE B	Installer level #SECONDARY INSTAL.P menu	To be customised	"Setting the heating curve", page 37
MAX. CIRC. B	Installer level #SECONDARY LIMITS menu	To be customised	"Professional settings", page 40

### 4.4.4. Connecting two circuits and a domestic hot water tank

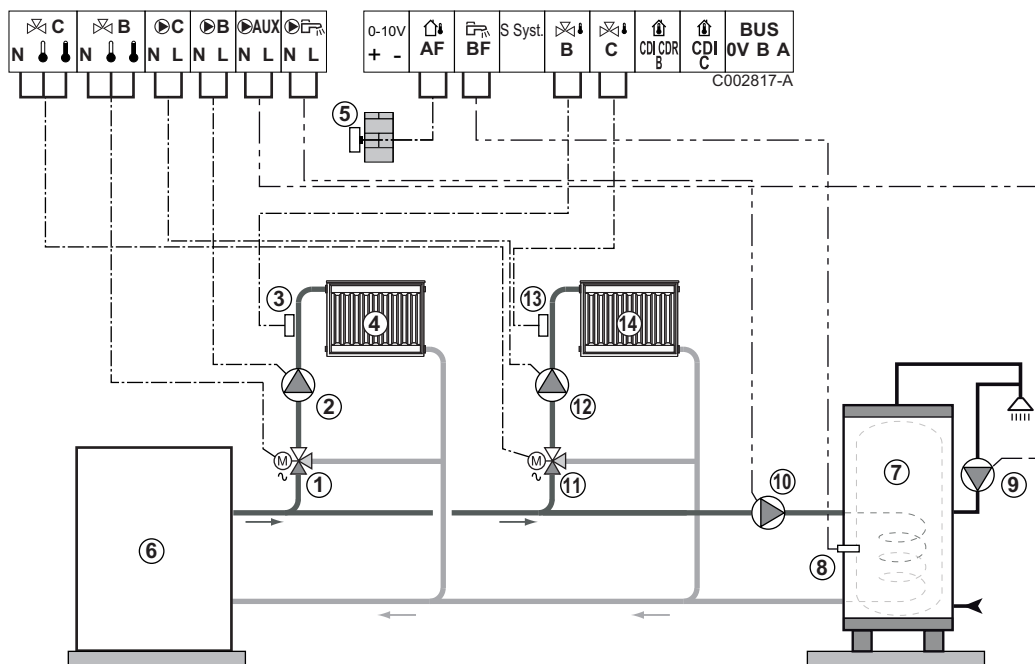

- ① 3 way valve circuit B
- ② Heating pump circuit B
- ③ Outlet sensor circuit B
- ④ Heating circuit B
- ⑤ Outside sensor
- ⑥ Boiler
- ⑦ DHW storage tank
- ⑧ DHW sensor
- ⑨ Domestic circulation loop pump (Optional)
- ⑩ D.H.W. load pump
- ⑪ 3 way valve circuit C
- ⑫ Heating pump circuit C
- ⑬ Outlet sensor circuit C
- ⑭ Heating circuit C



Earth the various pumps and 3-way valves.



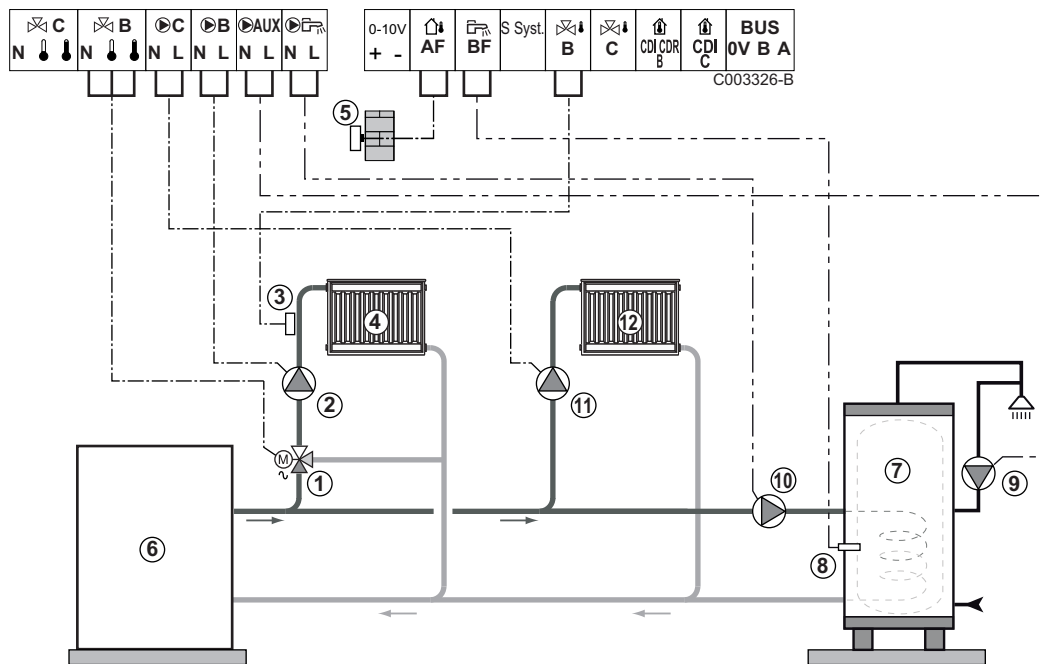

Settings to be made for this type of installation			
Parameters	Access	Settings to be made	See chapter
INSTALLATION	Installer level #SYSTEM menu	EXTENDED	"Displaying the parameters in extended mode", page 33
CIRC.CURVE B	Installer level #SECONDARY INSTAL.P menu	To be customised	"Setting the heating curve", page 37
MAX. CIRC. B	Installer level #SECONDARY LIMITS menu	To be customised	"Professional settings", page 40
CIRC.CURVE C	Installer level #SECONDARY INSTAL.P menu	To be customised	"Setting the heating curve", page 37
MAX. CIRC. C	Installer level #SECONDARY LIMITS menu	To be customised	"Professional settings", page 40

### 4.4.5. Connecting a direct circuit, a valve circuit and a DHW tank



- ① 3 way valve circuit B
- ② Heating pump circuit B
- ③ Outlet sensor circuit B
- ④ Heating circuit B
- ⑤ Outside sensor
- ⑥ Boiler
- ⑦ DHW storage tank
- ⑧ DHW sensor
- ⑨ Domestic circulation loop pump (Optional)
- ⑩ D.H.W. load pump

- ⑪ Heating pump circuit C
  - ⑫ Heating circuit C
- i** Earth the various pumps and 3-way valves.

Settings to be made for this type of installation			
Parameters	Access	Settings to be made	See chapter
<b>INSTALLATION</b>	Installer level <b>#SYSTEM</b> menu	<b>EXTENDED</b>	 "Displaying the parameters in extended mode", page 33
<b>CIRC.CURVE B</b>	Installer level <b>#SECONDARY INSTAL.P</b> menu	To be customised	 "Setting the heating curve", page 37
<b>MAX. CIRC. B</b>	Installer level <b>#SECONDARY LIMITS</b> menu	To be customised	 "Professional settings", page 40
If circuit C is a direct circuit without a flow sensor: <b>CIRC. C:</b> <sup>(1)</sup>	Installer level <b>#SYSTEM</b> menu	<b>DIRECT</b>	 "Setting the parameters specific to the installation", page 34
<b>CIRC.CURVE C</b>	Installer level <b>#SECONDARY INSTAL.P</b> menu	To be customised	 "Setting the heating curve", page 37

(1) The parameter is only displayed if **INSTALLATION** parameter is set to **EXTENDED**.

#### 4.4.6. Hot water storage tank connection

##### ■ QUADRO DU storage tank

In this installation example, the storage tank (type QUADRO DU) incorporates a domestic hot water zone. The boiler starts up systematically to maintain the domestic hot water zone in the storage tank or to maintain the independent tank at temperature.

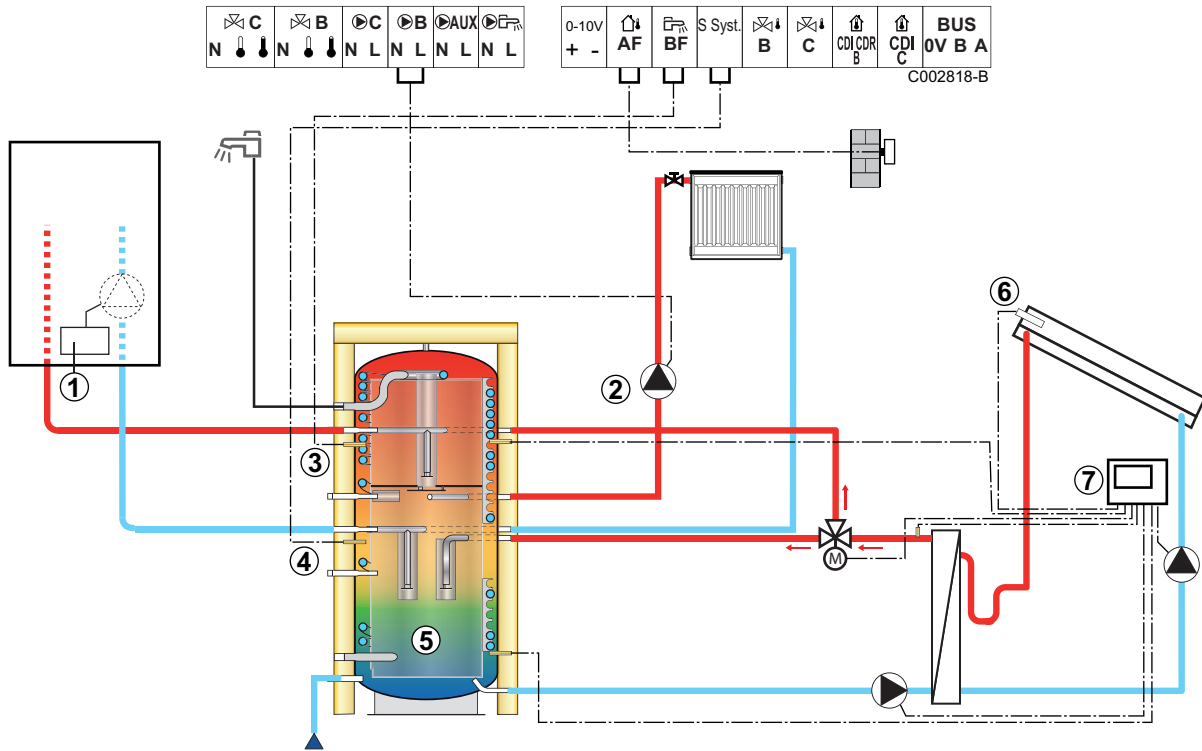

**i** This type of installation only works if the boiler incorporates a boiler pump managed by the boiler regulator.

- ① Boiler regulator
- ② Connect the heating pump (Circuit B).
- ③ DHW sensor
- ④ Connect the sensor from the storage tank (Package AD250).
- ⑤ Buffer tank.
- ⑥ Solar sensor probe.
- ⑦ Connect the solar station to the solar collectors.

Settings to be made for this type of installation			
Parameters	Access	Settings to be made	See chapter
<b>INSTALLATION</b>	Installer level #SYSTEM menu	<b>EXTENDED</b>	"Displaying the parameters in extended mode", page 33
<b>I.SYST</b>	Installer level #SYSTEM menu	<b>STORAGE TANK</b>	"Setting the parameters specific to the installation", page 34
If circuit B is a direct circuit without a flow sensor: <b>CIRC. B:(1)</b>	Installer level #SYSTEM menu	<b>DIRECT</b>	"Setting the parameters specific to the installation", page 34
(1) The parameter is only displayed if <b>INSTALLATION</b> parameter is set to <b>EXTENDED</b> .			



The DHW part is maintained at the DHW set point by the boiler.  
 The heating zone is maintained at the set temperature calculated according to the outside temperature. The zone is reheated when the heating buffer temperature sensor ⑤ falls -6°C below the calculated set temperature. Reheating in the heating zone stops when the heating buffer temperature rises above the calculated set temperature.

### 4.4.7. Pool connection

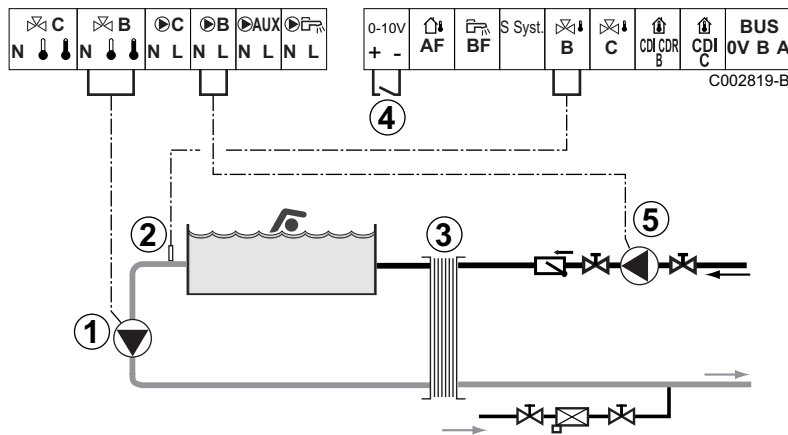





- ① Connect the secondary swimming pool pump.
- ② Connect the swimming pool sensor.
- ③ Plate heat exchanger.
- ④ Pool heating cut-off control



When the parameter **I.TEL:** is on **0/1 B**, the swimming pool is no longer heated when the contact is open (factory setting), only the antifreeze continues to be active. The contact direction can still be adjusted by the parameter **CT.TEL**.

- ⑤ Connect the primary swimming pool pump.
- ⑥ Do not connect anything to the terminal block.



Settings to be made for this type of installation			
Parameters	Access	Settings to be made	See chapter
<b>INSTALLATION</b>	Installer level <b>#SYSTEM</b> menu	<b>EXTENDED</b>	 "Displaying the parameters in extended mode", page 33
<b>MAX. CIRC. B</b>	Installer level <b>#SECONDARY LIMITS</b> menu	Set the value of <b>MAX.CIRC.B</b> to the temperature corresponding to the needs of the exchanger	 "Professional settings", page 40
<b>CIRC. B:</b> <sup>(1)</sup>	Installer level <b>#SYSTEM</b> menu	<b>SWIM.P.</b>	 "Setting the parameters specific to the installation", page 34
If a heating shutdown command is connected to the 0-10V inlet on the terminal block: <b>IN 0-10V</b>	Installer level <b>#SYSTEM</b> menu	<b>NO</b>	 "Setting the parameters specific to the installation", page 34
If a heating shutdown command is connected to the 0-10V inlet on the terminal block: <b>I.TEL:</b> <sup>(2)</sup>	Installer level <b>#SYSTEM</b> menu	<b>0/1 B</b>	 "Setting the parameters specific to the installation", page 34
(1) The parameter is only displayed if <b>INSTALLATION</b> parameter is set to <b>EXTENDED</b> .			
(2) The parameter is only displayed if the parameter <b>IN 0-10V</b> is set to <b>OFF</b> .			

## ■ Controlling the pool circuit

The control system can be used to manage a swimming pool circuit in both cases:

### Case 1: The control system regulates the primary circuit (boiler/exchanger) and the secondary circuit (exchanger/pool).

- ▶ Connect the primary circuit pump (boiler/exchanger) to the pump **B** outlet. The temperature **MAX.CIRC.B** is then guaranteed during comfort periods on programme **B** in summer and winter alike.
- ▶ Connect the pool sensor (package AD212) to the **S OUTL B** input.
- ▶ Set the set point of the pool sensor using key  in the range 5 - 39°C.

### Case 2: The pool has already a regulation system that is to be kept. The control system only regulates the primary circuit (boiler/exchanger).

- ▶ Connect the primary circuit pump (boiler/exchanger) to the pump **B** outlet.  
The temperature **MAX.CIRC.B** is then guaranteed during comfort periods on programme **B** in summer and winter alike.



The swimming pool can also be connected to circuit **C** by adding the AD249 option:

- ▶ Make the connection to the terminal blocks marked **C**.
- ▶ Set the parameters for circuit **C**.

### ■ Hourly programming of the secondary circuit pump

The secondary pump operates during programme **B** comfort periods in summer and winter alike.

### ■ Stopping

To prepare your pool for winter, consult your pool specialist.

#### 4.4.8. Connecting a mixed tank

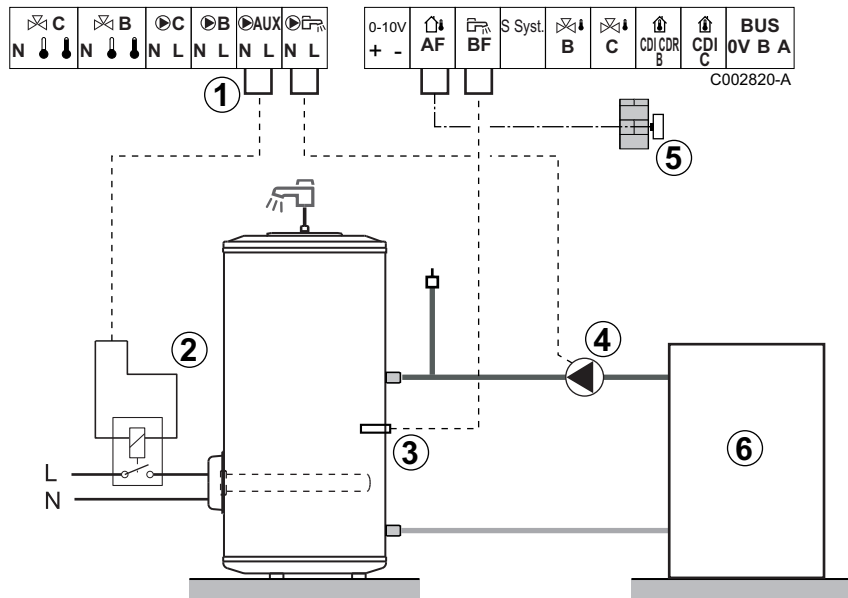

- ① Connect the electric tank
- ② Power control relay to the electrical resistor
- ③ DHW sensor
- ④ D.H.W. load pump
- ⑤ Connect the outside temperature sensor
- ⑥ Boiler

Settings to be made for this type of installation			
Parameters	Access	Settings to be made	See chapter
<b>INSTALLATION</b>	Installer level #SYSTEM menu	<b>EXTENDED</b>	"Displaying the parameters in extended mode", page 33
<b>S.AUX:</b> <sup>(1)</sup>	Installer level #SYSTEM menu	<b>DHW ELEC</b>	"Setting the parameters specific to the installation", page 34

(1) The parameter is only displayed if **INSTALLATION** parameter is set to **EXTENDED**.

#### 4.4.9. Connecting the options

For example: TELCOM remote vocal monitoring module, remote controls for circuits **B** and **C**, second DHW tank

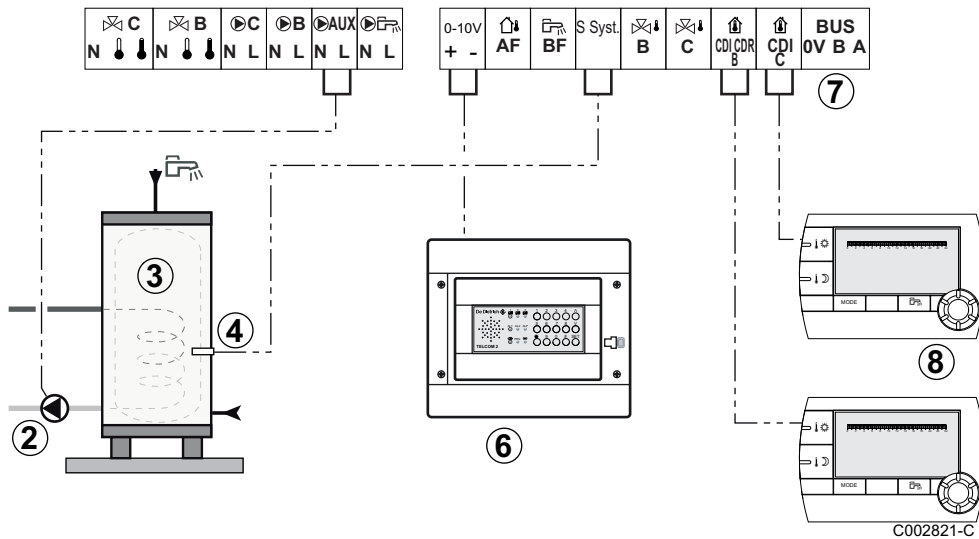

- ② Connect the load pump of the second tank.
- ③ Second domestic hot water tank.
- ④ Connect the DHW sensor of the second tank.
- ⑥ Connect the TELCOM remote vocal monitoring module. (depending on its availability in your country).
- ⑦ Connecting the BUS cascade, VM.  
Use a shielded cable connected on each side of the earth.
- ⑧ Connect the remote control (Package AD258/FM52).

Settings to be made for this type of installation			
Parameters	Access	Settings to be made	See chapter
<b>INSTALLATION</b>	Installer level #SYSTEM menu	<b>EXTENDED</b>	"Displaying the parameters in extended mode", page 33
If second tank connected: <b>S.AUX:</b> <sup>(1)</sup>	Installer level #SYSTEM menu	<b>DHW</b>	"Setting the parameters specific to the installation", page 34
If a remote monitoring module is connected to the 0-10V inlet on the terminal block: <b>IN 0-10V</b>	Installer level #SYSTEM menu	<b>NO</b>	"Setting the parameters specific to the installation", page 34
If a remote monitoring module is connected to the 0-10V inlet on the terminal block: <b>I.TEL:</b> <sup>(2)</sup>	Installer level #SYSTEM menu	<b>ANTIFR</b>	"Setting the parameters specific to the installation", page 34
(1) The parameter is only displayed if <b>INSTALLATION</b> parameter is set to <b>EXTENDED</b> .			
(2) The parameter is only displayed if the parameter <b>IN 0-10V</b> is set to <b>OFF</b> .			

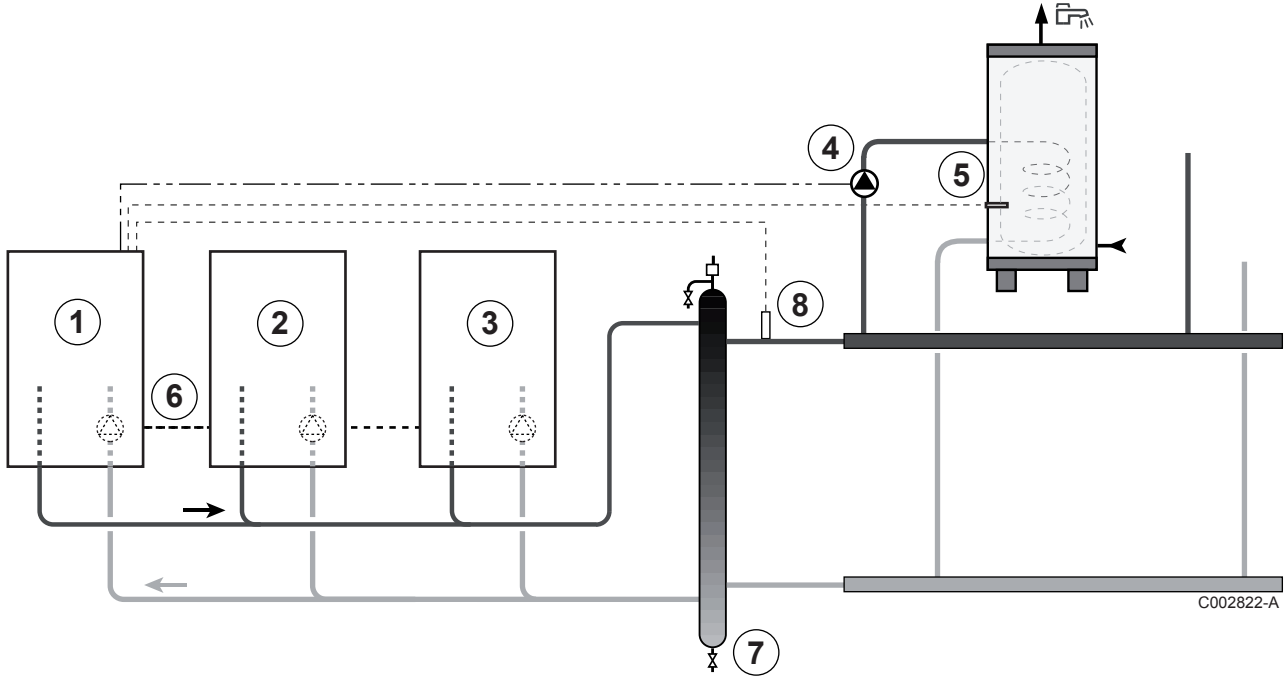

### 4.4.10. Connection in cascade

#### ■ DHW tank after the mixing tank



- ① Master boiler
- ② Secondary boiler
- ③ Secondary boiler
- ④ D.H.W. load pump
- ⑤ DHW sensor
- ⑥ Cable **BUS**
- ⑦ Low loss header
- ⑧ Cascade outlet sensor  
Connect the sensor to the terminal block **E.SYST** on the master boiler.

Settings to be made for this type of installation: Master boiler			
Parameters	Access	Settings to be made	See chapter
<b>INSTALLATION</b>	Installer level #SYSTEM menu	<b>EXTENDED</b>	☞ "Displaying the parameters in extended mode", page 33
<b>CASCADE:</b> <sup>(1)</sup>	Installer level #NETWORK menu	<b>ON</b>	☞ "Configuring the network", page 45
<b>MASTER CONTROLLER</b> <sup>(1)</sup>	Installer level #SYSTEM menu	<b>ON</b>	
<b>SYSTEM NETWORK</b> <sup>(1)</sup>	Installer level #SYSTEM menu	<b>ADD GENE MANU</b>	
<sup>(1)</sup> The parameter is only displayed if <b>INSTALLATION</b> parameter is set to <b>EXTENDED</b>			

Settings to be made for this type of installation: Follower boilers			
Parameters	Access	Settings to be made	See chapter
<b>INSTALLATION</b>	Installer level <b>#SYSTEM</b> menu	<b>EXTENDED</b>	 "Displaying the parameters in extended mode", page 33
<b>CASCADE:(1)</b>	Installer level <b>#NETWORK</b> menu	<b>ON</b>	 "Configuring the network", page 45
<b>MASTER CONTROLLER(1)</b>	Installer level <b>#SYSTEM</b> menu	<b>OFF</b>	
<b>SLAVE NUMBER(1)</b>	Installer level <b>#SYSTEM</b> menu	2, 3, ...	

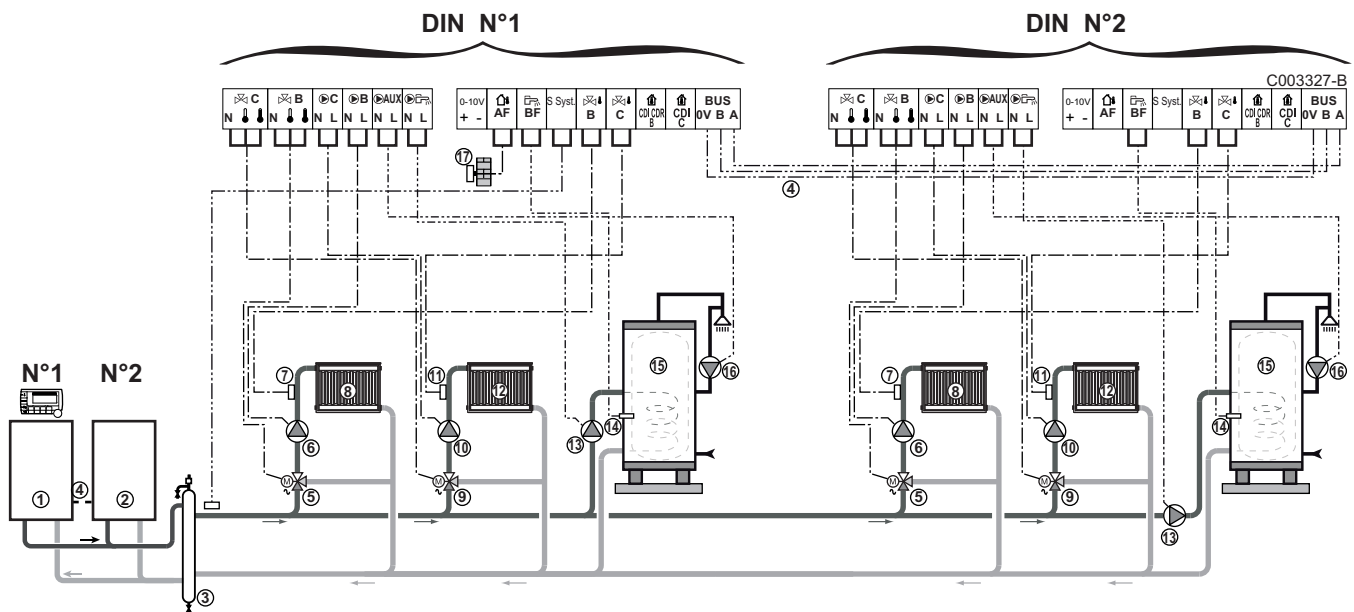

(1) The parameter is only displayed if **INSTALLATION** parameter is set to **EXTENDED**

■ Connecting 2 x 2 valve circuits and a DHW tank





- ① Master boiler
- ② Secondary boiler
- ③ Low loss header
- ④ BUS cable to make the link between boilers
- ⑤ 3 way valve circuit B
- ⑥ Heating pump circuit B
- ⑦ Outlet sensor circuit B
- ⑧ Heating circuit B
- ⑨ 3 way valve circuit C
- ⑩ Heating pump circuit C
- ⑪ Outlet sensor circuit C
- ⑫ Heating circuit C
- ⑬ D.H.W. load pump
- ⑭ DHW sensor
- ⑮ DHW storage tank
- ⑯ Domestic circulation loop pump (Optional)

⑰ Outside sensor

Settings to be made for this type of installation: Master boiler			
Parameters	Access	Settings to be made	See chapter
<b>INSTALLATION</b>	Installer level <b>#SYSTEM</b> menu	<b>EXTENDED</b>	 "Displaying the parameters in extended mode", page 33
<b>CASCADE:</b> <sup>(1)</sup>	Installer level <b>#NETWORK</b> menu	<b>ON</b>	 "Configuring the network", page 45
<b>MASTER CONTROLLER</b> <sup>(1)</sup>	Installer level <b>#SYSTEM</b> menu	<b>ON</b>	
<b>SYSTEM NETWORK</b> <sup>(1)</sup>	Installer level <b>#SYSTEM</b> menu	<b>ADD GENE MANU</b>	

(1) The parameter is only displayed if **INSTALLATION** parameter is set to **EXTENDED**

Settings to be made for this type of installation: Follower boilers			
Parameters	Access	Settings to be made	See chapter
<b>INSTALLATION</b>	Installer level <b>#SYSTEM</b> menu	<b>EXTENDED</b>	 "Displaying the parameters in extended mode", page 33
<b>CASCADE:</b> <sup>(1)</sup>	Installer level <b>#NETWORK</b> menu	<b>ON</b>	 "Configuring the network", page 45
<b>MASTER CONTROLLER</b> <sup>(1)</sup>	Installer level <b>#SYSTEM</b> menu	<b>OFF</b>	
<b>SLAVE NUMBER</b> <sup>(1)</sup>	Installer level <b>#SYSTEM</b> menu	2, 3, ...	

(1) The parameter is only displayed if **INSTALLATION** parameter is set to **EXTENDED**

# 5 Operating the appliance

## 5.1 Powering up for the first time

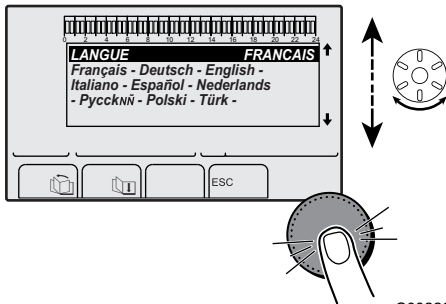

C002286-C

The first time the boiler is powered up, the **#LANGUAGE** menu is displayed.

1. Select the desired language by turning the rotary button.
2. To confirm, press the rotary button.

## 5.2 Access to the various browsing levels

### 5.2.1. User level

The information and settings in the User level can be accessed by everyone.

1. Press the → key.

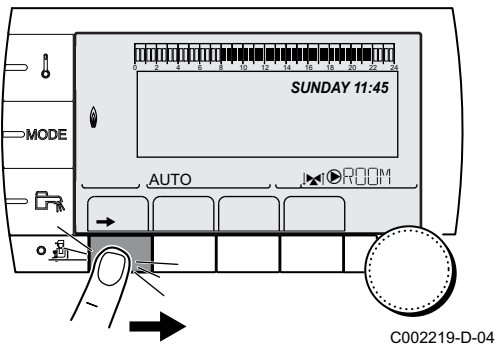

C002219-D-04

### 5.2.2. Installer level

The information and settings in the Installer level can be accessed by experienced people.

1. Press key  for around 5 seconds.

**i** Before the Installer level is displayed, the **#EMISSION MEASUREMENTS** menu will be displayed. Hold down the  key until **#LANGUAGE** is displayed.

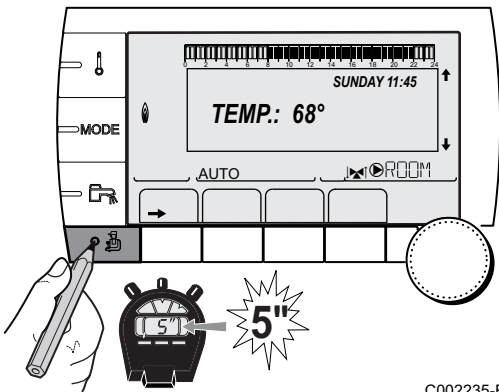

C002235-F-04

### 5.2.3. After Sales level

The information and settings in the After Sales level can be accessed by initiates.

1. Press key  for around 10 seconds.

**i** Before the After Sales level is displayed, the Installer level will be displayed. Hold down the  key until **#PARAMETERS** is displayed.

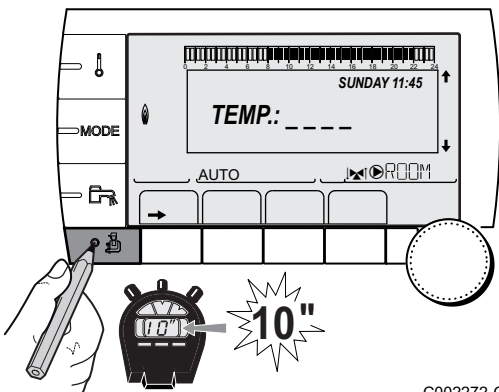

C002272-C-04

## 5.3 Browsing in the menus

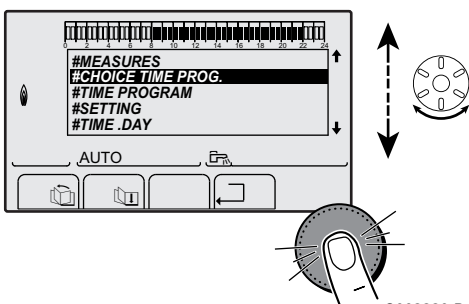

C002220-B-04

1. To select the desired menu, turn the rotary button.
2. To access the menu, press the rotary button.  
To go back to the previous display, press the key .



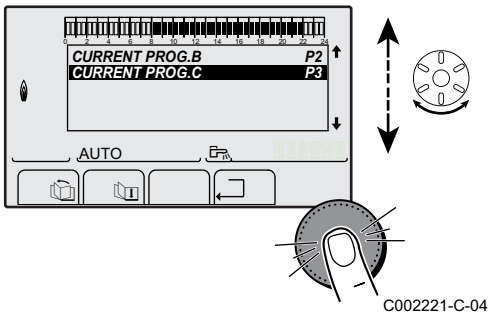

3. To select the desired parameter, turn the rotary button.
4. To modify the parameter, press the rotary button.  
To go back to the previous display, press the key  $\square$ .

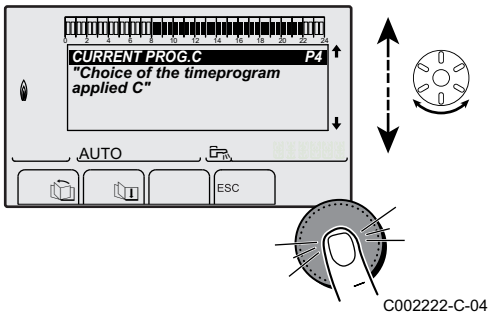

5. To modify the parameter, turn the rotary button.
6. To confirm, press the rotary button.

**i** To cancel, press key **ESC**.

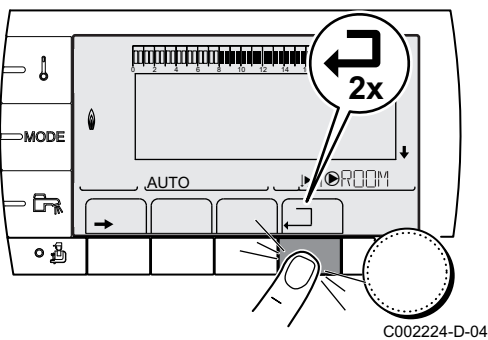

7. To go back to the main display, press key  $\square$  2 times.

**i** It is possible to use the  $\square$  and  $\square$  keys instead of the rotary button.

## 5.4 Reading out measured values

The various values measured by the appliance are displayed in the **#MEASURES** menu.

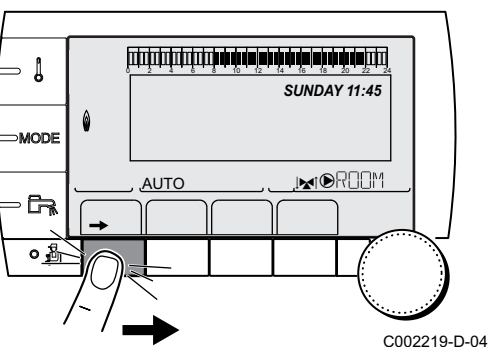

1. To access user level: Press the  $\rightarrow$  key.
2. Select the menu **#MEASURES**.

**i**

- ▶ Turn the rotary button to scroll through the menus or modify a value.
- ▶ Press the rotary button to access the menu selected or confirm a value modification.

**i** For a detailed explanation of menu browsing, refer to the chapter: "Browsing in the menus", page 31.

User level - #MEASURES menu		
Parameter	Description	Unit
<b>OUTSIDE TEMP.</b>	Outside temperature	°C
<b>ROOMTEMP. B</b> <sup>(1)</sup>	Room temperature of circuit B	°C
<b>ROOMTEMP. C</b> <sup>(1)</sup>	Room temperature of circuit C	°C
<b>BOILER TEMP.</b>	Water temperature in the boiler	°C

(1) The parameter is only displayed for the options, circuits or sensors actually connected.

User level - #MEASURES menu		
Parameter	Description	Unit
<b>WATER TEMP.</b> <sup>(1)</sup>	Water temperature in the DHW tank	°C
<b>STOR.TANK.TEMP</b> (1)	Water temperature in the storage tank	°C
<b>SWIMMING P.T.B</b> (1)	Water temperature of the swimming pool on circuit B	°C
<b>SWIMMING P.T.C</b> (1)	Water temperature of the swimming pool on circuit C	°C
<b>OUTLET TEMP. B</b> (1)	Temperature of the flow water in circuit B	°C
<b>OUTLET TEMP. C</b> (1)	Temperature of the flow water in circuit C	°C
<b>SYSTEM TEMP.</b> <sup>(1)</sup>	Temperature of the system flow water if multi-generator	°C
<b>T.DHW BOTTOM</b> (1)	Water temperature in the bottom of the DHW tank	°C
<b>TEMP.TANK AUX</b> (1)	Water temperature in the second DHW tank connected to the AUX circuit	°C
<b>IN 0-10V</b> <sup>(1)</sup>	Voltage at input 0-10 V	V
<b>DIN CTRL</b>	Software control number	

(1) The parameter is only displayed for the options, circuits or sensors actually connected.

## 5.5 Settings after powering up for the first time

### 5.5.1. Displaying the parameters in extended mode

The display mode on the control panel is set as standard in such a way as only to show the conventional parameters. It is possible to switch to extended mode by proceeding as follows:

1. Access the installer level: Press key  for around 5 seconds.
2. Select the menu **#SYSTEM**.



- ▶ Turn the rotary button to scroll through the menus or modify a value.
- ▶ Press the rotary button to access the menu selected or confirm a value modification.

 For a detailed explanation of menu browsing, refer to the chapter: "Browsing in the menus", page 31

3. Set parameter **INSTALLATION** to **EXTENDED**.

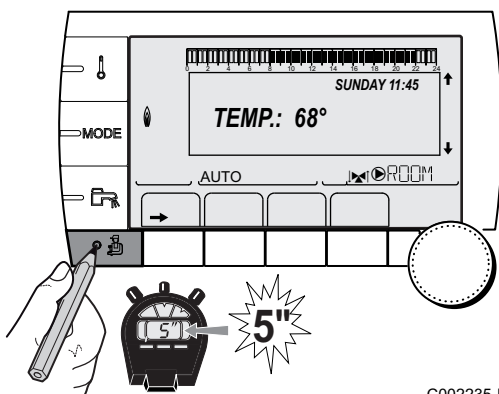

C002235-F-04

Installer level - Menu #SYSTEM				
Parameter	Adjustment range	Description	Factory setting	Customer setting
<b>INSTALLATION</b>	<b>CLASSIC</b>	Displays the parameters of a conventional installation	<b>CLASSIC</b>	
	<b>EXTENDED</b>	Displays all parameters		



Regardless of what is done to the keys, the regulator switches back to **CLASSIC** mode after 30 minutes.

### 5.5.2. Setting the parameters specific to the installation

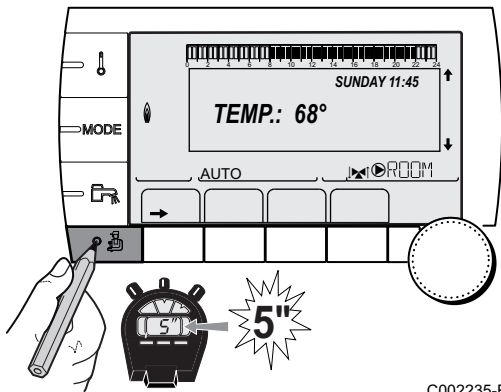

C002235-F-04

1. Access the installer level: Press key for around 5 seconds.
2. Select the menu **#SYSTEM**.



- ▶ Turn the rotary button to scroll through the menus or modify a value.
- ▶ Press the rotary button to access the menu selected or confirm a value modification.



For a detailed explanation of menu browsing, refer to the chapter: "Browsing in the menus", page 31

3. Set the following parameters according to the connections made to the PCBs:

Installer level - #SYSTEM menu				
Parameter	Adjustment range	Description	Factory setting	Customer setting
CIRC. B: <sup>(1)</sup>	3WV	Connecting a circuit with 3-way valve ( For example: Underfloor heating)	3WV	
	SWIM.P.	Using the circuit for pool management		
	DIRECT	Use of circuit in direct heating circuit Check and set the heating curve if necessary. See chapter:  "Setting the heating curve", page 37		
CIRC. C: <sup>(1)</sup>	3WV	Connecting a circuit with 3-way valve ( For example: Underfloor heating)	3WV	
	SWIM.P.	Using the circuit for pool management		
	DIRECT	Use of circuit in direct heating circuit Check and set the heating curve if necessary. See chapter:  "Setting the heating curve", page 37		
S.AUX: <sup>(1)</sup>	DHW LOOP	Use as a domestic loop pump	DHW LOOP	
	PROGRAM.	Use as an independent programmable outlet		
	PRIMARY PUMP	The outlet <b>AUX PUMP</b> is active if a heating demand is present on the secondary pump		
	DHW	Use of primary circuit of second DHW tank		
	FAILURE	The outlet <b>AUX PUMP</b> is active if a fault is detected		
	DHW ELEC	Used to control the electrical resistor according to the timer programme on circuit AUX in summer mode		
I.SYST <sup>(1)</sup>	SYSTEM	The inlet sensor is used to connect the common flow sensor of a cascade system	SYSTEM	
	STORAGE TANK	Hot water storage tank affected to heating only		
	DHW STRAT	Using the DHW tank with 2 sensors (top and bottom)		
	ST.TANK+DHW	Hot water storage tank affected to heating and domestic hot water		

(1) The parameter is only displayed if **INSTALLATION** parameter is set to **EXTENDED**  
 (2) The parameter is only displayed if the parameter **IN 0-10V** is set to **OFF**

Installer level - #SYSTEM menu				
Parameter	Adjustment range	Description	Factory setting	Customer setting
CT.TEL (1)	CLOSE	See table below.	CLOSE	
	OPEN			
I.TEL: (1)(2)	ANTIFR	Start anti-freeze in boiler command	ANTIFR	
	0/1 B	ON or OFF contact: <b>I.TEL:</b> can be used as an antifreeze activation inlet on circuit B		
	0/1 C	ON or OFF contact: <b>I.TEL:</b> can be used as an antifreeze activation inlet on circuit C		
	0/1 DHW	ON or OFF contact: <b>I.TEL:</b> can be used as an antifreeze activation inlet on circuit ECS		
	0/1 AUX	ON or OFF contact: <b>I.TEL:</b> can be used as an antifreeze activation inlet on circuit AUX ( <b>S.AUX:</b> if the AD 249 option is connected) When <b>I.TEL:</b> is not active, the auxiliary circuit (AUX) follows the maximum boiler temperature (parameter <b>BOILER MAX</b> ).		
IN 0-10V	OFF	The 0-10V inlet on the terminal block can be used as a telephone inlet.	OFF	
	ON	Activating the control at 0-10 V		
DIN CONFIG	OTH+3WV	Do not modify	OTH+3WV	

(1) The parameter is only displayed if **INSTALLATION** parameter is set to **EXTENDED**  
 (2) The parameter is only displayed if the parameter **IN 0-10V** is set to **OFF**

Influence of the parameter setting CT.TEL on the I.TEL contact			
CT.TEL	I.TEL:	I.TEL contact closed	I.TEL contact open
CLOSE	ANTIFR	The antifreeze mode is active on all boiler circuits.	The mode selected on the boiler is active.
	0/1 B	The mode selected on the circuit is active.	The antifreeze mode is active on the circuit concerned.
	0/1 C	The mode selected on the circuit is active.	The antifreeze mode is active on the circuit concerned.
	0/1 DHW	The mode selected on the DHW circuit is active.	The antifreeze mode is active for the DHW circuit.
	0/1 AUX	<ul style="list-style-type: none"> <li>▶ The <b>AUX</b> outlet on the connection terminal block is active.</li> <li>▶ The boiler operates at a set point temperature equal to <b>BOILER MAX</b>.</li> </ul>	<ul style="list-style-type: none"> <li>▶ The <b>AUX</b> outlet on the connection terminal block is not active.</li> <li>▶ The boiler operates with a set point temperature as a function of the outside temperature.</li> </ul>
OPEN	ANTIFR	The mode selected on the boiler is active.	The antifreeze mode is active on all boiler circuits.
	0/1 B	The antifreeze mode is active on the circuit concerned.	The mode selected on the circuit is active.
	0/1 C	The antifreeze mode is active on the circuit concerned.	The mode selected on the circuit is active.
	0/1 DHW	The antifreeze mode is active for the DHW circuit.	The mode selected on the DHW circuit is active.
	0/1 AUX	<ul style="list-style-type: none"> <li>▶ The <b>AUX</b> outlet on the connection terminal block is not active.</li> <li>▶ The boiler operates with a set point temperature as a function of the outside temperature.</li> </ul>	<ul style="list-style-type: none"> <li>▶ The <b>AUX</b> outlet on the connection terminal block is active.</li> <li>▶ The boiler operates at a set point temperature equal to <b>BOILER MAX</b>.</li> </ul>

### 5.5.3. Naming the circuits and generators

1. Access the installer level: Press key  for around 5 seconds.
2. Select the menu **#NAMES OF THE CIRCUITS**.

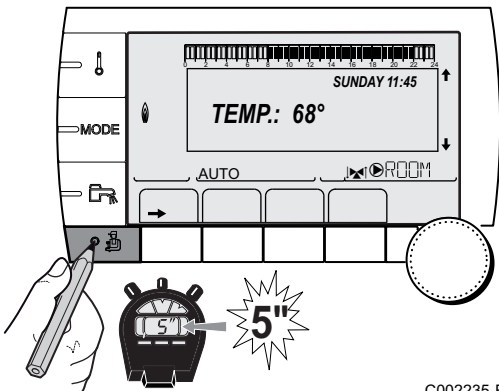

- i** Turn the rotary button to scroll through the menus or modify a value.
  - Press the rotary button to access the menu selected or confirm a value modification.
-  For a detailed explanation of menu browsing, refer to the chapter: "Browsing in the menus", page 31

3. Select the circuit or generator you wish to rename.

Installer level - #NAMES OF THE CIRCUITS menu		
Parameter	Description	Name given by the customer
<b>CIRC. B:</b>	Circuit B	
<b>CIRC. C:</b>	Circuit C	
<b>CIRC.AUX</b>	Auxiliary circuit	
<b>CIRC.DHW</b>	Domestic hot water circuit	
<b>GENE</b>	Generator	

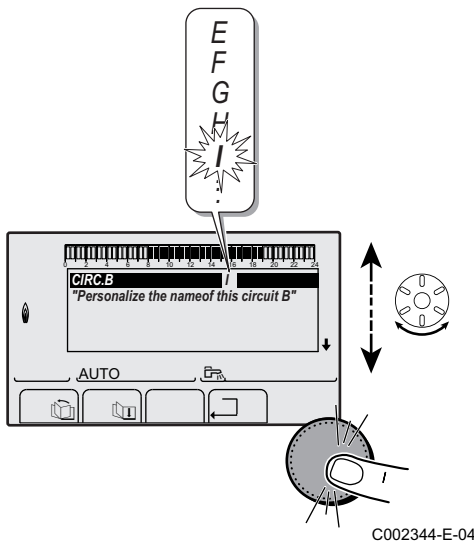

4. Turn the rotary button to choose the first character from the list. To confirm, press the rotary button.
5. Then press again to enter a second character or turn the rotary button to leave an empty space.
6. Choose the other characters in the same way. The input zone may contain up to 6 characters.

- i** To move from one character to another, turn the rotary button. To exit without modifications, press key **ESC**.

7. To confirm the name, press the rotary button and then turn the button slightly anti-clockwise. When the symbol  appears, press the rotary button. The name is confirmed.

- i** If the name reaches 6 characters, it is automatically confirmed when the last character is confirmed.

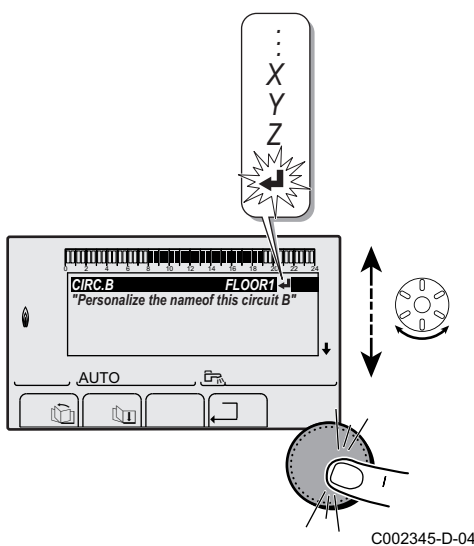

### 5.5.4. Setting the heating curve

If an outside temperature sensor is connected, it is possible to adapt the heating curve.

1. Access the installer level: Press key  for around 5 seconds.
2. Select the menu **#SECONDARY INSTAL.P.**

- i**
  - ▶ Turn the rotary button to scroll through the menus or modify a value.
  - ▶ Press the rotary button to access the menu selected or confirm a value modification.

 For a detailed explanation of menu browsing, refer to the chapter: "Browsing in the menus", page 31

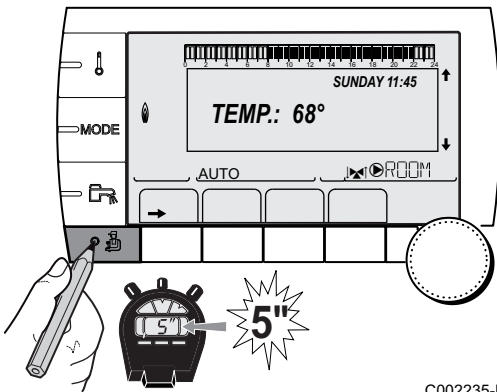

C002235-F-04

3. Select the parameter **CIRC. CURVE ...**

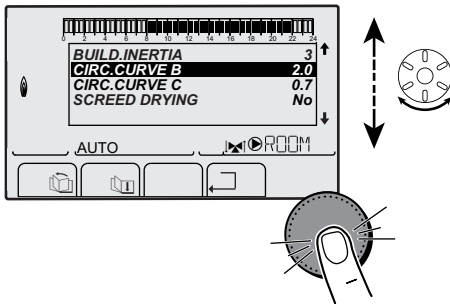

C002316-E-04

4. To modify the value directly, turn the rotary button.  
To modify the value by displaying the curve, press key .

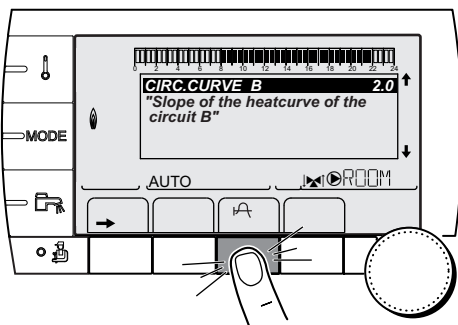

C002317-D-04

5. To modify the curve, turn the rotary button.
6. To confirm, press the rotary button.  
To cancel, press key **ESC**.

- i** **0.7 = Heating curve set**

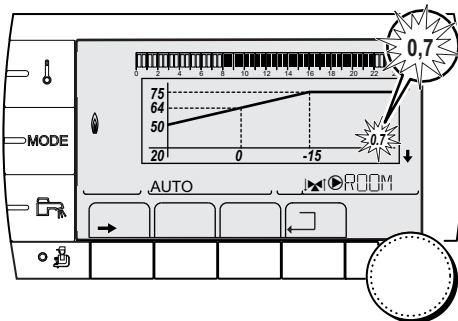

C002318-B-04

#### ■ Heating curve without BCT

The BCT (Base heat Curve Temperature) allows a minimum operating temperature to be imposed on the heating circuit (this temperature may be constant if the circuit gradient is nil).

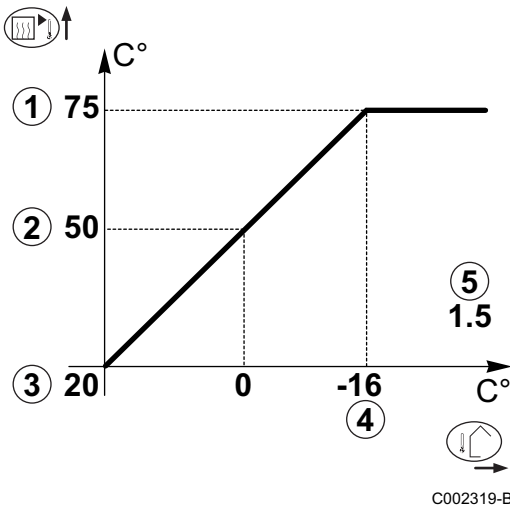

- ① Maximum temperature of the circuit
  - ② Water temperature in the circuit for an outside temperature of 0°C
  - ③ **DAY** set point on the circuit
  - ④ Outside temperature for which the maximum water temperature in the circuit is reached
  - ⑤ Value of the heating curve  
This value corresponds to the parameter **HEAT.CURV.**
- i** When you modify the heating curve, ② and ⑤ are recalculated and repositioned automatically.

### ■ Heating curve with BCT

The BCT (Base heat Curve Temperature) allows a minimum operating temperature to be imposed on the heating circuit (this temperature may be constant if the circuit gradient is nil).

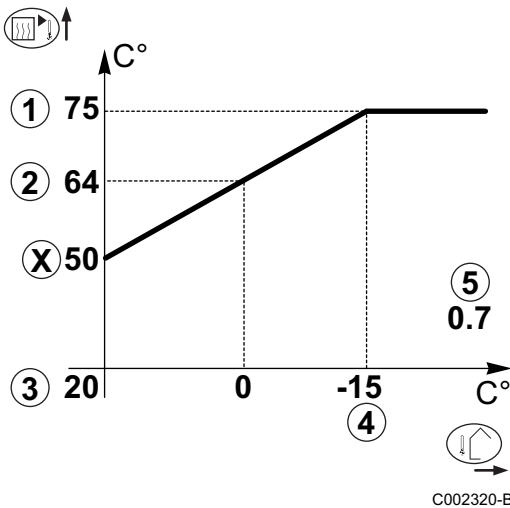

- ① Maximum temperature of the circuit
  - ② Water temperature in the circuit for an outside temperature of 0°C
  - ③ **DAY** set point on the circuit
  - ④ Outside temperature for which the maximum water temperature in the circuit is reached
  - ⑤ Value of the heating curve  
This value corresponds to the parameter **HEAT.CURV.**
  - x Value set to the parameter **HCZP D**
- i** When you modify the heating curve, ② and ⑤ are recalculated and repositioned automatically.

## 5.6 Changing the settings

The boiler control panel is set for the most common heating systems. With these settings, practically all heating systems operate correctly. The user or installer can optimise the parameters according to own preferences.

**👉** For the user settings, refer to the user instructions.

### 5.6.1. Language selection

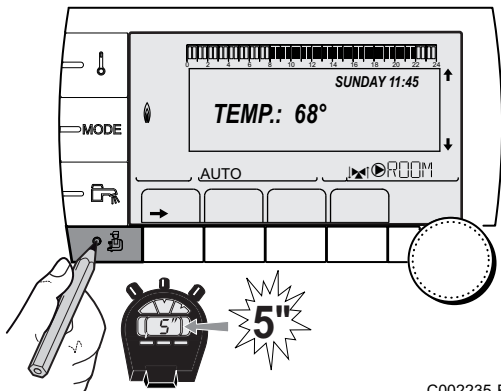

C002235-F-04

1. Access the installer level: Press key for around 5 seconds.
2. Select the menu **#LANGUAGE**.



- ▶ Turn the rotary button to scroll through the menus or modify a value.
- ▶ Press the rotary button to access the menu selected or confirm a value modification.



For a detailed explanation of menu browsing, refer to the chapter: "Browsing in the menus", page 31

Installer level - Menu #LANGUAGE	
Adjustment range	Description
FRANCAIS	Display in French
DEUTSCH	Display in German
ENGLISH	Display in English
ITALIANO	Display in Italian
ESPANOL	Display in Spanish
NEDERLANDS	Display in Dutch
РУССКИЙ	Display in Russian
POLSKY	Display in Polish
TÜRK	Display in Turkish

### 5.6.2. Calibrating the sensors

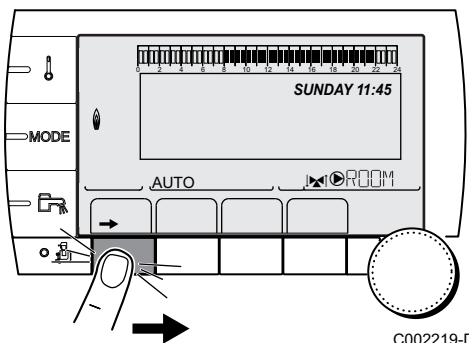

C002219-D-04

1. To access user level: Press the → key.
2. Select the menu **#SETTING**.



- ▶ Turn the rotary button to scroll through the menus or modify a value.
- ▶ Press the rotary button to access the menu selected or confirm a value modification.



For a detailed explanation of menu browsing, refer to the chapter: "Browsing in the menus", page 31

3. To set the following parameters:



User level - #SETTING menu				
Parameter	Adjustment range	Description	Factory setting	Customer setting
<b>SUM/WIN</b>	15 to 30 °C	Used to set the outside temperature above which heating will be shut down. ▶ The heating pumps are shut down. ▶ The burner will only start for domestic hot water needs. ▶ The symbol ☹ appears.	22 °C	
	<b>NO</b>	Heating is never shut down automatically		
<b>CALIBR. OUT</b>		Outside sensor calibration: Used to correct the outside temperature	Outside temperature	
<b>CALIBR. ROOM B</b> (1)(1)		Calibration of the room sensor on circuit B: Is used to set a room offset Make this setting 2 hours after switching on, when the room temperature has stabilised	Room temperature of circuit B	
<b>OFFSET ROOM B</b> (1)	-5.0 to +5.0 °C	Room offset on circuit B: Is used to set a room offset Make this setting 2 hours after switching on, when the room temperature has stabilised	0.0	
<b>ANTIFR. ROOM B</b>	0.5 to 20 °C	Room temperature at which the antifreeze mode is activated on circuit B	6 °C	
<b>CALIBR. ROOM C</b> (2)(1)		Calibration of the room sensor on circuit C: Is used to set a room offset Make this setting 2 hours after switching on, when the room temperature has stabilised	Room temperature of circuit C	
<b>OFFSET ROOM C</b> (3) (1)	-5.0 to +5.0 °C	Room offset on circuit C: Is used to set a room offset Make this setting 2 hours after switching on, when the room temperature has stabilised	0.0	
<b>ANTIFR. ROOM C</b> (4)	0.5 to 20 °C	Room temperature antifreeze activation on circuit C	6 °C	
(1) The parameter is only displayed if <b>INSTALLATION</b> parameter is set to <b>EXTENDED</b> (2) The parameter is only displayed if a room sensor is connected to the circuit concerned (3) The parameter is only displayed if no room sensor is connected to the circuit concerned or the sensor has no influence (4) The parameter is only displayed if the circuit concerned is actually connected				

### 5.6.3. Professional settings

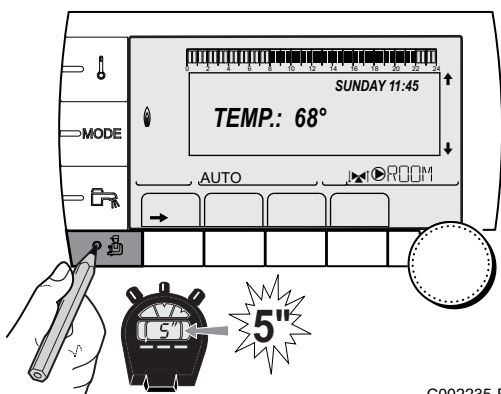

C002235-F-04



1. Access the installer level: Press key  for around 5 seconds.
2. To set the following parameters:









- ▶ Turn the rotary button to scroll through the menus or modify a value.
- ▶ Press the rotary button to access the menu selected or confirm a value modification.









For a detailed explanation of menu browsing, refer to the chapter: "Browsing in the menus", page 31.

Installer level - #SECONDARY LIMITS menu			
Parameter	Adjustment range	Description	Factory setting
<b>MAX.CIRC.B</b>	20 to 95 °C	Maximum temperature (Circuit B)  "MAX.CIRC...", page 43	50 °C
<b>MAX.CIRC.C</b>	20 to 95 °C	Maximum temperature (Circuit C)  "MAX.CIRC...", page 43	50 °C
<b>OUT.ANTIFREEZE</b>	<b>OFF</b> , -8 to +10 °C	Outside temperature at which the installation's antifreeze protection is activated. Below this temperature the pumps are permanently on and the minimum temperatures for each circuit are respected. When <b>NIGHT : STOP</b> is set, the reduced temperature is maintained in each circuit (#SECONDARY INSTAL.P menu). <b>OFF</b> : Antifreeze protection is not activated	+3 °C
<b>HCZP D B</b> <sup>(1)(2)</sup>	<b>OFF</b> , 20 to 90 °C	Curve base temperature in Daytime mode (Circuit B)	<b>OFF</b>
<b>HCZP N B</b> <sup>(1)(2)</sup>	<b>OFF</b> , 20 to 90 °C	Curve base temperature in Nighttime mode (Circuit B)	<b>OFF</b>
<b>HCZP D C</b> <sup>(1)(2)</sup>	<b>OFF</b> , 20 to 90 °C	Curve base temperature in Daytime mode (Circuit C)	<b>OFF</b>
<b>HCZP N C</b> <sup>(1)(2)</sup>	<b>OFF</b> , 20 to 90 °C	Curve base temperature in Nighttime mode (Circuit C)	<b>OFF</b>
<b>PRIM.TEMP.DHW</b> <sup>(1)</sup>	50 to 90 °C	Boiler temperature setting if producing domestic hot water	80 °C

(1) The parameter is only displayed if **INSTALLATION** parameter is set to **EXTENDED**  
(2) The parameter can be set to the heating curve by pressing key .

Installer level - #SECONDARY INSTAL.P menu				
Parameter	Adjustment range	Description	Factory setting	Customer setting
<b>BUILD. INERTIA</b> <sup>(1)</sup>	0 (10 hours) to 10 (50 hours)	Characterisation of building's inertia: 0 for a building with low thermal inertia. 3 for a building with normal thermal inertia. 10 for a building with high thermal inertia. <b>Modification of the factory setting is only useful in exceptional cases.</b>	3 (22 hours)	
<b>CIRC.CURVE B</b> <sup>(2)</sup>	0 to 4	Heating curve of the circuit B  "CIRC. CURVE ...", page 43	0.7	
<b>ROOM INFL. B</b> <sup>(1)</sup>	0 to 10	Influence of room sensor B  "ROOM S.INFL", page 44	3	
<b>CIRC.CURVE C</b> <sup>(2)</sup>	0 to 4	Heating curve of the circuit C  "CIRC. CURVE ...", page 43	0.7	
<b>ROOM INFL. C</b> <sup>(1)</sup>	0 to 10	Influence of room sensor C  "ROOM S.INFL", page 44	3	
<b>SCREED DRYING</b>	<b>NO, B, C, B+C</b>	Drying the floor  "SCREED DRYING", page 43	<b>NO</b>	
<b>START DRYING TEMP</b> <sup>(3)</sup>	20 to 50 °C	Screed drying start temperature	20 °C	
<b>STOP DRYING TEMP</b> <sup>(3)</sup>	20 to 50 °C	Screed drying stop temperature	20 °C	
<b>NB DAYS DRYING</b> <sup>(3)</sup>	0 to 99		0	

(1) The parameter is only displayed if **INSTALLATION** parameter is set to **EXTENDED**  
(2) The parameter can be set to the heating curve by pressing key   
(3) The parameter is only displayed if **SCREED DRYING** is other than **OFF**  
(4) The parameter is only displayed if **IN 0-10V** is set to **ON**.  
(5) If a reversal valve is connected, DHW priority will always be total regardless of the setting.

Installer level - #SECONDARY INSTAL.P menu				
Parameter	Adjustment range	Description	Factory setting	Customer setting
<b>NIGHT</b> <sup>(1)</sup>	<b>DEC.</b>	The lower temperature is maintained (Night mode)  "NIGHT", page 44	<b>DEC.</b>	
	<b>STOP</b>	The boiler is stopped (Night mode)  "NIGHT", page 44		
<b>IN 0-10V</b>	<b>OFF / TEMPERATURE / POWER %</b>	Activating the control at 0-10 V  "Function 0-10 V", page 45	<b>OFF</b>	
<b>VMIN/OFF 0-10V</b> <sup>(1)(4)</sup>	0 to 10 V	Voltage corresponding to the instruction set minimum	0.5 V	
<b>VMAX 0-10V</b> <sup>(1)(4)</sup>	0 to 10 V	Voltage corresponding to the instruction set maximum	9.5 V	
<b>CONS.MIN 0-10V</b> <sup>(1)</sup> <sup>(4)</sup>	10 to 70 °C	Instruction minimum set temperature	20 °C	
<b>CONS.MAX 0-10V</b> <sup>(1)</sup> <sup>(4)</sup>	10 to 100 °C	Maximum set temperature	80 °C	
<b>BAND WIDTH</b> <sup>(1)</sup>	4 to 16 K	Control unit bandwidth for the 3-way valves. Option of increasing the bandwidth if the valves are rapid or of reducing it if they are slow.	<b>12 K</b>	
<b>BOIL/3WV SHIFT</b> <sup>(1)</sup>	0 to 16 K	Minimum temperature difference between the boiler and the valves	<b>4 K</b>	
<b>H. PUMP DELAY</b> <sup>(1)</sup>	0 to 15 minutes	Timing of the shutdown of the heating pumps. The timing of heating pump shutdown prevents the boiler overheating.	<b>4 minutes</b>	
<b>HW. PUMP DELAY</b> <sup>(1)</sup>	2 to 15 minutes	Timing of the shutdown of the domestic hot water pump. The timing of the domestic hot water load pump shutdown prevents the boiler and the heating circuits overheating (Only if a load pump is used).	<b>2 minutes</b>	
<b>ADAPT</b>	<b>ON</b>	Automatic adaptation of the heating curves for each circuit with a room sensor with an influence of >0.	<b>ON</b>	
	<b>OFF</b>	The heating curves can only be modified manually.		
<b>PRIORITY DHW</b> <sup>(5)</sup>	<b>TOTAL</b>	Interruption of pool heating and reheating during domestic hot water production.	<b>TOTAL</b>	
	<b>SLIDING</b>	Domestic hot water production and heating on the valve circuits if the available output is sufficient and the hydraulic connection allows.		
	<b>NO</b>	Heating and domestic hot water production in parallel if the hydraulic connection allows.  Risk of overheating in the direct circuit.		
<p>(1) The parameter is only displayed if <b>INSTALLATION</b> parameter is set to <b>EXTENDED</b></p> <p>(2) The parameter can be set to the heating curve by pressing key </p> <p>(3) The parameter is only displayed if <b>SCREED DRYING</b> is other than <b>OFF</b></p> <p>(4) The parameter is only displayed if <b>IN 0-10V</b> is set to <b>ON</b>.</p> <p>(5) If a reversal valve is connected, DHW priority will always be total regardless of the setting.</p>				

Installer level - #SECONDARY INSTAL.P menu				
Parameter	Adjustment range	Description	Factory setting	Customer setting
<b>LEG PROTEC</b>		The anti legionella function acts to prevent the development of legionella in the dhw tank, these bacteria are responsible for legionellosis.	<b>OFF</b>	
	<b>OFF</b>	Anti-legionella function not activated		
	<b>DAILY</b>	The tank is overheated every day from 4:00 o'clock to 5:00 o'clock		
	<b>WEEKLY</b>	The tank is overheated every Saturday from 4:00 o'clock to 5:00 o'clock		
(1) The parameter is only displayed if <b>INSTALLATION</b> parameter is set to <b>EXTENDED</b> (2) The parameter can be set to the heating curve by pressing key $\curvearrowright$ (3) The parameter is only displayed if <b>SCREED DRYING</b> is other than <b>OFF</b> (4) The parameter is only displayed if <b>IN 0-10V</b> is set to <b>ON</b> . (5) If a reversal valve is connected, DHW priority will always be total regardless of the setting.				

■ **MAX.CIRC...**



**WARNING**

If using underfloor heating, do not modify the factory setting (50 °C). To install this, please consult existing legislation.

- ▶ In the case of a direct circuit, connect a safety thermostat to the BL contact.
- ▶ In the case of a 3-way valve circuit (B or C), connect a safety thermostat to the TS contact.

■ **CIRC. CURVE ...**

**Heating curve circuit B or C**

- x** Outside temperature (°C)
- y** Water flow temperature (°C)
- ① Maximum temperature of the circuit B - C

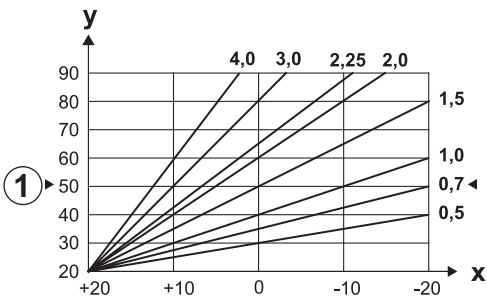

M001678-B

■ **SCREED DRYING**

Used to force a constant flow temperature or a train to accelerate screed drying on underfloor heating.

The setting for these temperatures must follow the screed-layer's recommendations.

The activation of this parameter (setting other than **OFF**) forces the permanent display of **SCREED DRYING** and deactivates all other functions on the control unit.

When floor drying is active on a circuit, all other circuits (e.g. DHW) are shut down. The use of this function is only possible on circuits B and C.

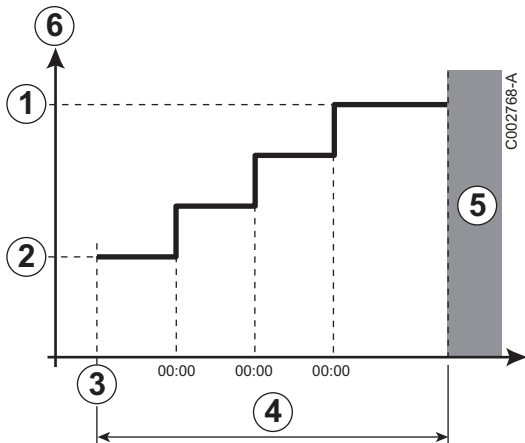

- ① **STOP DRYING TEMP**
- ② **START DRYING TEMP**
- ③ Today
- ④ **NB DAYS DRYING**
- ⑤ Normal regulation (End of drying)
- ⑥ Heating temperature setting (°C)

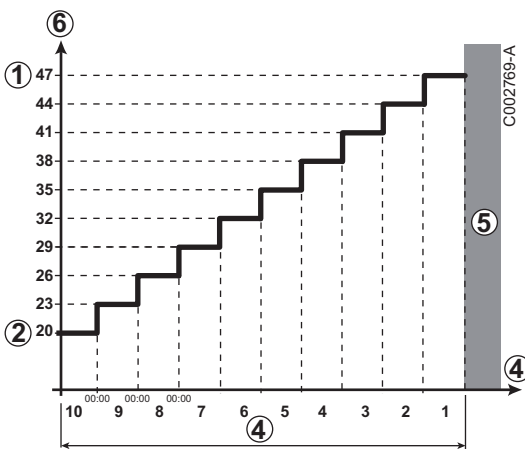

- For example**
- ① **STOP DRYING TEMP: 47 °C**
  - ② **START DRYING TEMP: 20 °C**
  - ④ **NB DAYS DRYING**
  - ⑤ Normal regulation (End of drying)
  - ⑥ Heating temperature setting (°C)



Every day at midnight (00:00): the set point (**START DRYING TEMP**) is recalculated and the remaining number of days (**NB DAYS DRYING**) is decremented.

### ■ ROOM S.INFL

Used to adjust the influence of the room sensor on the water temperature for the circuit concerned.

0	No influence (remote control fitted in a location with no influence)
1	Slight influence
3	Average influence (recommended)
10	Room thermostat type operation

### ■ NIGHT



This parameter is displayed if at least one circuit does not include a room sensor.

#### For circuits without a room sensor:

- ▶ **NIGHT :DEC.** (Reduced): The reduced temperature is maintained during reduced periods. The circuit pump operates constantly.
- ▶ **NIGHT :STOP** (Stop): Heating is shut down during reduced periods. When installation antifreeze is active, the reduced temperature is maintained during reduced periods.

**For circuits with a room sensor:**

- ▶ When the room temperature is lower than the room sensor set point: The reduced temperature is maintained during reduced periods. The circuit pump operates constantly.
- ▶ When the room temperature is higher than the room sensor set point: Heating is shut down during reduced periods. When installation antifreeze is active, the reduced temperature is maintained during reduced periods.

**■ Function 0-10 V**

This function controls the boiler using an external system that includes a 0-10 V output connected to the 0-10 V input. This control imposes an instruction set temperature on the boiler. It will be necessary to ensure that the parameter **BOILER MAX** is higher than **CONS.MAX 0-10V**.

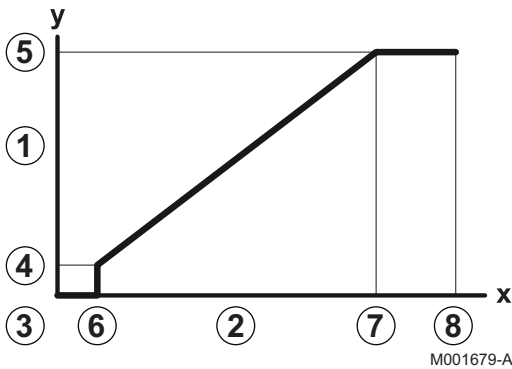

M001679-A

- 1 Instruction set outlet temperature (°C)
- 2 Power input signal (V) - DC
- 3 0 V
- 4 **CONS.MIN 0-10V**
- 5 **CONS.MAX 0-10V**
- 6 **VMIN/OFF 0-10V**
- 7 **VMAX 0-10V**
- 8 10 V
- x Voltage at input
- y Boiler temperature

If the input voltage is less than **VMIN/OFF 0-10V**, the boiler is off. The boiler temperature setting corresponds strictly to the 0-10 V input. The secondary boiler circuits continue to operate but have no impact on the water temperature in the boiler. If using the 0-10 V input and a secondary boiler circuit, the external regulator providing this 0-10 V power supply must always request a temperature at least equal to the needs of the secondary circuit.

**5.6.4. Configuring the network**

1. Access the installer level: Press key for around 5 seconds.
2. Select the menu **#NETWORK**.

- ▶ Turn the rotary button to scroll through the menus or modify a value.
- ▶ Press the rotary button to access the menu selected or confirm a value modification.

For a detailed explanation of menu browsing, refer to the chapter: "Browsing in the menus", page 31

3. To set the following parameters:

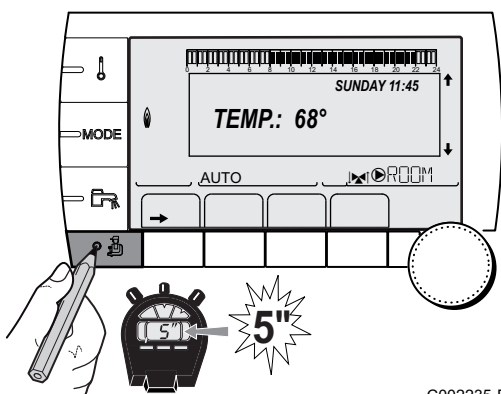

C002235-F-04

Installer level - Menu #NETWORK <sup>(1)</sup>				
Parameter	Adjustment range	Description	Factory setting	Customer setting
<b>CASCADE:</b>	<b>ON / NO</b>	<b>ON:</b> System in cascade	<b>NO</b>	
<b>MASTER CONTROLLER</b> (2)	<b>ON / NO</b>	Configure this control system as master on the bus	<b>ON</b>	
<b>SYSTEM NETWORK</b> (3)		Specific menu: Enlist generators or VMs in cascade mode (See following chapter: "Connecting appliances in cascade")		
<b>FUNCT</b> (3)	<b>CLASSIC</b>	Operation in cascade: Successive triggering of the various boilers in the cascade according to requirements	<b>CLASSIC</b>	
	<b>PARALLEL</b>	Functioning in parallel cascade: If the outside temperature is lower than the value <b>PARALLEL CASC.</b> , all of the boilers are started up at the same time		
<b>PARALLEL CASC.</b> (4)	-10 to 20 °C	Outside temperature triggering all stages in parallel mode	10 °C	
<b>TIMER GENE P. CASC</b> (2)	0 to 30 min	Minimum duration of post-operation of the generator pump	0 mn	
<b>INTER STAGE TIMER</b> (2)	1 to 30 min	Time delay for starting up or shutting down generators.	4 mn	
<b>SLAVE NUMBER</b> (5)	2 to 10	Set the network address of the secondary generator	2	
<b>3WW PLC</b>		Specific menu (Not used)		
<b>InOne SCENARIO</b>		Specific menu: Configure the InOne scenarios to be managed by the SCU PCB (See following chapter: "Configuring the scenarios")		
<b>REMOVE DEVICE</b>		Specific menu: see below		

(1) The menu is displayed only if the **INSTALLATION** parameter is set to **EXTENDED**  
 (2) The parameter is only displayed if **CASCADE:** is set to **ON**  
 (3) The parameter is only displayed if **MASTER CONTROLLER** is set to **ON**  
 (4) The parameter is only displayed if **FUNCT** is set to **PARALLEL**  
 (5) The parameter is only displayed if **MASTER CONTROLLER** is set to **OFF**

### ■ Connecting appliances in cascade

It is possible, in a cascade configuration, to enlist generators and/or VMs as slaves. Proceed as follows:

1. Set **CASCADE:** to **ON** by pressing the rotary button and then turning and pressing it again to confirm.
2. Select **SYSTEM NETWORK** and press the rotary button to go to the specific menu.

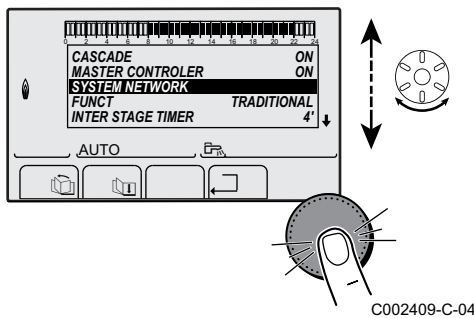

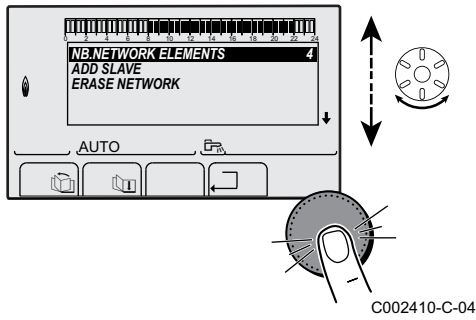

3. To add a slave appliance to the network, select **ADD GENE MANU**.

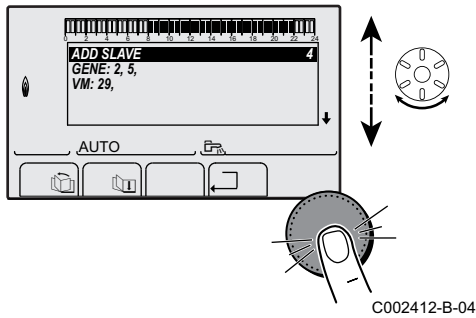

4. The screen displayed allows you to choose numbers for the slave boilers to be added to the network. Numbers 2 to 10 are dedicated to the generators and numbers 20 to 39 to the VM. Turn the rotary button to scroll through the numbers and press to confirm the number chosen. Press  $\square$  to go back to the previous list.

5. To remove a slave appliance from the network, select **ERASE NETWORK**.

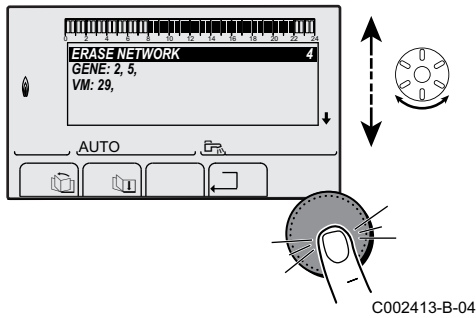

6. The screen displayed allows you to choose the numbers of the slave boilers to be removed from the network. Turn the rotary button to scroll through the numbers and press to remove the number chosen. Press  $\square$  to go back to the previous list.

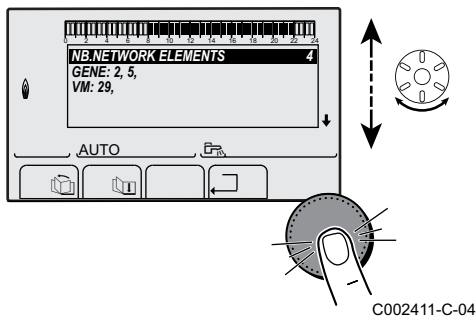

7. Select **NB. ELEMENTS.NETWORK**. This screen summarises the elements in the network recognised by the system. Press  $\square$  to go back to the previous list.

### ■ Configuring the scenarios

It is possible to choose a scenario and allocate it to various IOBL units via the carrier current. Proceed as follows:

1. In the menu **#NETWORK**, select **InOne SCENARIO**.

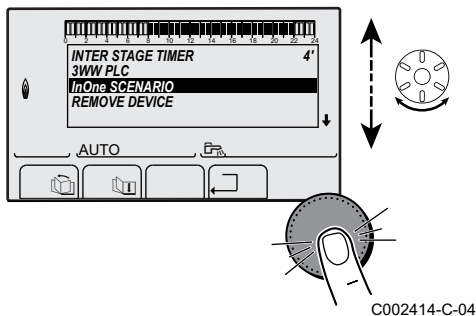



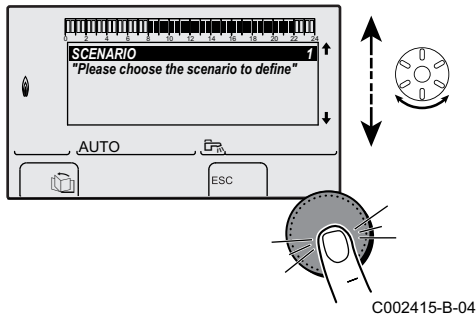

- Choose a number to allocate to the scenario by turning the rotary button, up to 4 scenarios can be saved. To confirm, press the rotary button.

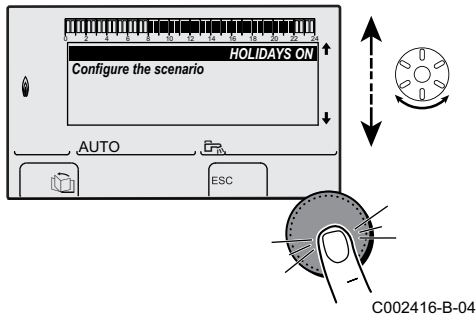

- Choose the desired scenario by turning the rotary button and then confirm.

Scenarios available	Description
<b>HOLIDAYS ON</b>	Holiday mode active (all circuits)
<b>HOLIDAYS OFF</b>	Holiday mode inactive (all circuits)
<b>OUT.AUX ON</b>	Aux outlet enabled
<b>OUT.AUX OFF</b>	Aux outlet disabled
<b>DHW DAY</b>	DHW in day mode
<b>DHW NIGHT</b>	DHW in night mode
<b>DEFAULT ON</b>	Default active
<b>DEFAULT OFF</b>	No active default
<b>INPUT TEL.ON</b>	Telephone input active
<b>INPUT TEL.OFF</b>	Telephone input not active

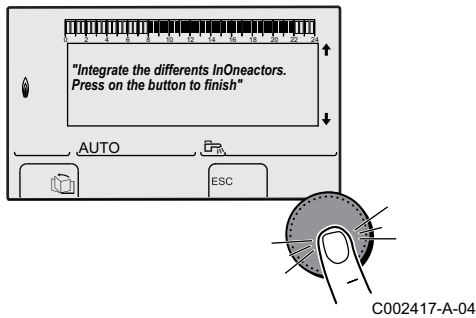

- Enlist the various InOne units that have to abide by the scenario and confirm by pressing the rotary button.

### ■ Removing a device

To remove a device, proceed as follows:

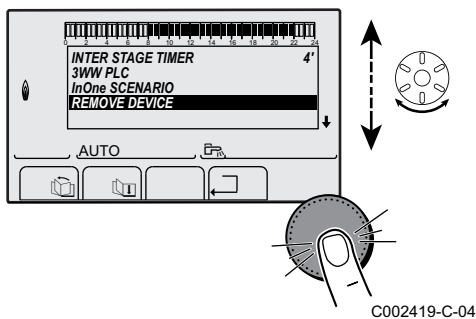

- In the menu **#NETWORK**, select **REMOVE DEVICE**.

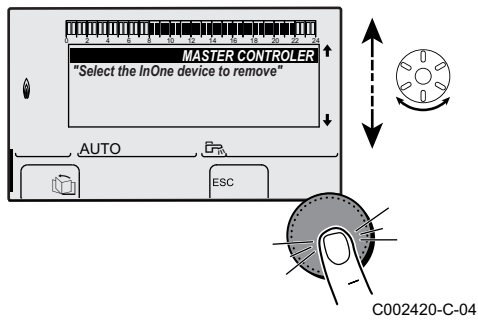

2. Choose the device to be removed by turning the rotary button and pressing to confirm.

### ■ Controlling the boiler from an IOBL Scenario Switch

It is possible to control the boiler from a scenario switch (the boiler is then considered a slave boiler). Proceed as follows:

1. Remove the cover from the IOBL scenario switch to access the LEARN key.

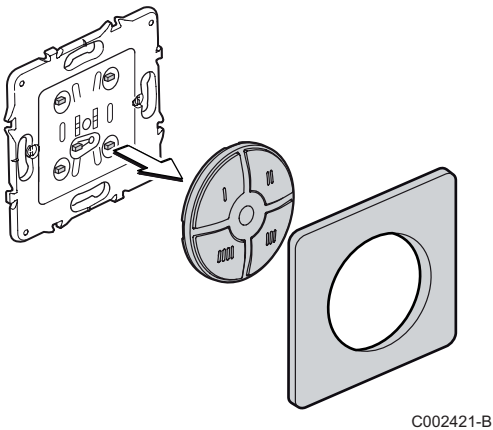

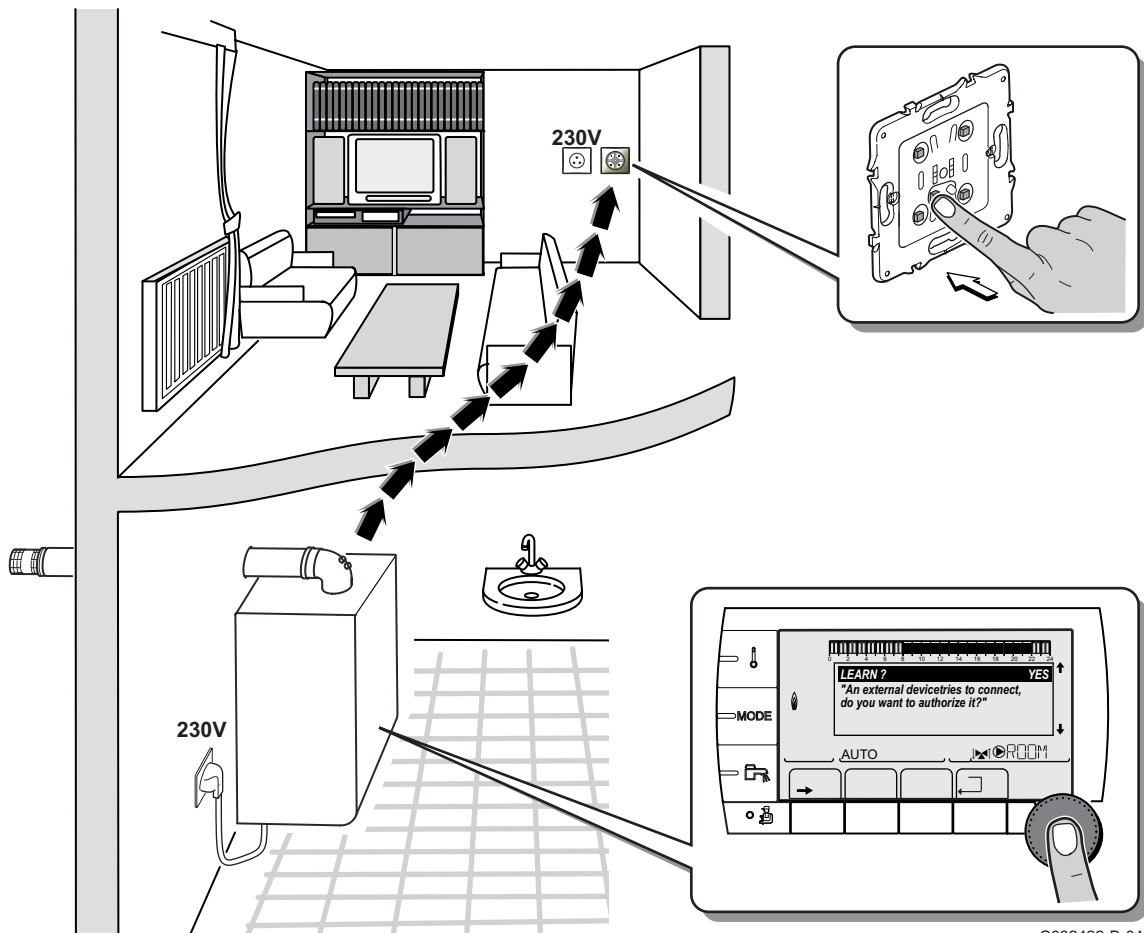

C002422-B-04

2. Press the LEARN key and the control key used to pilot the scenario. A pairing signal is sent to the boiler by carrier current, which displays the following message on the control panel: "A device is trying to connect, do you want to allow this?"
3. Set the display to **ON** by turning the rotary button and pressing to confirm.

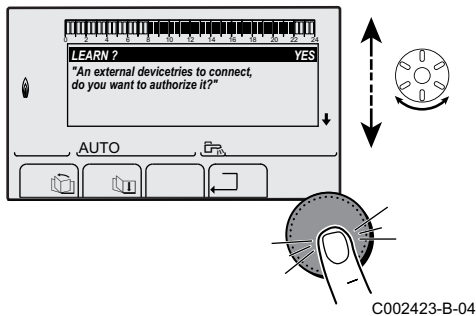

C002423-B-04

4. Choose the circuit used to run the scenario by turning the rotary button and pressing to confirm.

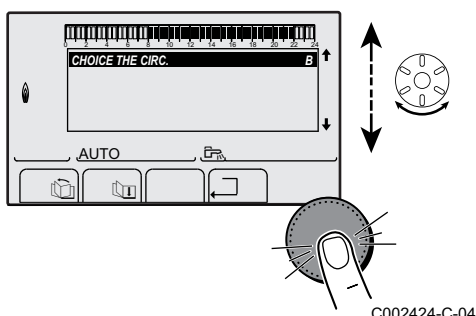

C002424-C-04



**CAUTION**

If one of the SCU PCBs is not correctly paired, the following message appears: "NB not all of the SCUs are recognised". Start the pairing procedure again.

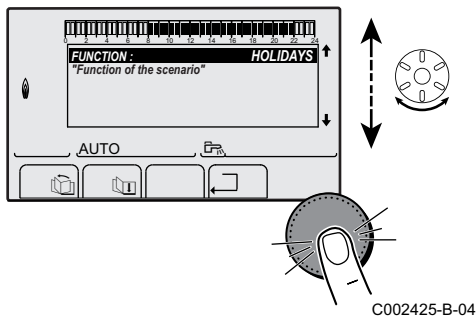

5. Choose the desired scenario by turning the rotary button and then confirm.

Scenarios available	Description
<b>AUTO</b>	Heating according to the time programme
<b>DAY</b>	Comfort mode
<b>NIGHT</b>	Reduced mode
<b>HOLIDAYS</b>	Holiday mode
P1	Programme P1 chosen
P2	Programme P2 chosen
P3	Programme P3 chosen
P4	Programme P4 chosen

6. Terminate pairing by pressing the LEARN key on the IOBL scenario switch.

### ■ Erasing a scenario from the IOBL Scenario Switch

It is possible to remove a scenario using the IOBL scenario switch. Proceed as follows:

1. Press the LEARN key on the scenario switch, then the control key that pilots the scenario to be erased. A message asking whether you wish to erase the scenario is displayed on the control panel interface.
2. Set the display to **ON** by turning the rotary button and pressing to confirm.

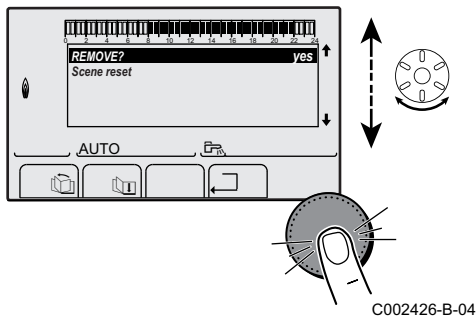

3. Confirm removal by pressing the LEARN key on the IOBL scenario switch.

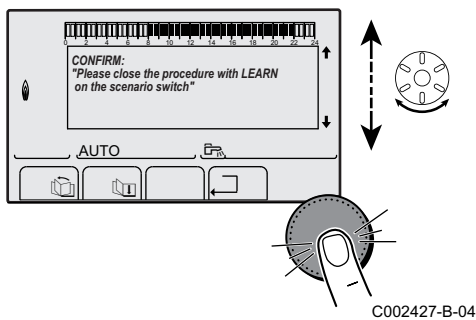

### 5.6.5. Return to the factory settings

To reset the appliance, proceed as follows:

1. Press key **↓**, **→** and **↶** simultaneously for 4 seconds. The menu **#RESET** is displayed.
2. To set the following parameters:

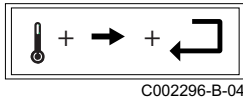
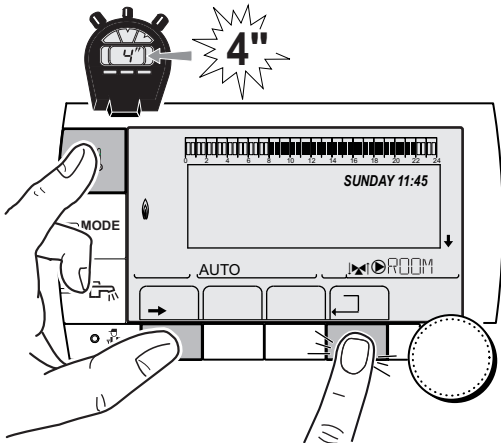

C002296-B-04

Menu #RESET			
Choice of generator	Parameter	Description	
GENERATOR	RESET	TOTAL	Performs a TOTAL RESET of all parameters
		EXCEPT PROG.	Performs a parameter RESET but retains the timer programmes
		PROG.	Performs a RESET on the timer programmes but retains the parameters
		IOBL	Resets the system's network connections
		SENSOR SCU	Performs a RESET of the generator sensors connected
		ROOM SENSOR	Performs a RESET of the room sensors connected

After reset (**TOTAL RESET** and **RESET EXCEPT PROG.**), the control system goes back to the display of the language choice after a few seconds.

1. Select the desired language by turning the rotary button.
2. To confirm, press the rotary button.

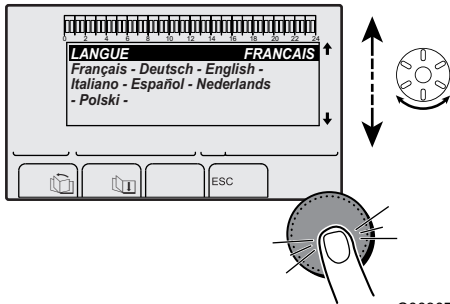

C003079-A

# 6 Switching off the appliance

---

## 6.1 Installation shutdown

---

If the central heating system is not used for a long period, we recommend switching the boiler off.

- ▶ Switch the On/Off switch on Off.
- ▶ Isolate the gas supply.
- ▶ Ensure that the boiler and system are protected against frost damage.

## 6.2 Frost protection

---



### CAUTION

If the home is unoccupied for a long period and there is a risk of frost, drain the boiler and the heating system.



### CAUTION

- ▶ The antifreeze protection does not function if the boiler is switched off.
- ▶ The integrated protection system only protects the boiler, not the installation. To protect the installation, set the appliance to **HOLIDAYS** mode.

The **HOLIDAYS** mode protects:

- ▶ The installation if the outside temperature is lower than 3°C (factory setting).
- ▶ The room temperature if a remote control is connected and the room temperature is lower than 6 °C (factory setting).
- ▶ The domestic hot water tank if the tank temperature is lower than 4 °C (the water is reheated to 10 °C).

To configure the holidays mode:  Refer to the user instructions.

# 7 Troubleshooting

## 7.1 Installer's contact details

To display the installer's telephone number when an error is displayed, proceed as follows:

1. Access the "After Sales" level: Hold key  down until **#PARAMETERS** is displayed.
2. Select the menu **#SUPPORT**.

- i** Turn the rotary button to scroll through the menus or modify a value.
- Press the rotary button to access the menu selected or confirm a value modification.

 For a detailed explanation of menu browsing, refer to the chapter: "Browsing in the menus", page 31

3. To set the following parameters:

After Sales level - #SUPPORT menu	
Parameter	Description
<b>NAME</b>	Input the installer's name
<b>TELEPHONE NUM.</b>	Input the installer's telephone number

When an error is displayed, press ? to display the installer's telephone number.

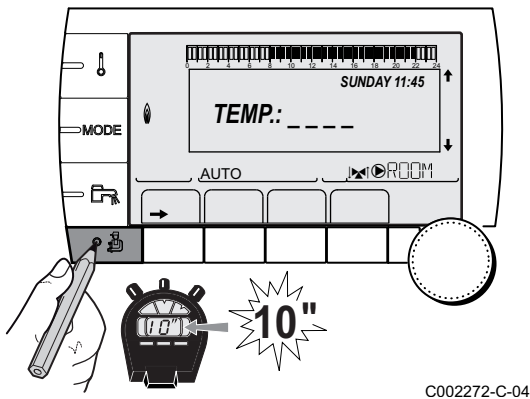

C002272-C-04

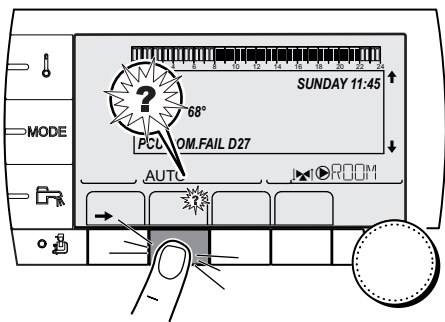

C002302-D-04

## 7.2 Messages

The iSense Pro DIN module may display the following messages:

Messages	Description	Checking / solution
<b>FL.DRY.B XX DAYS</b>	Floor drying is active <b>XX DAYS</b> = Number of days' floor drying remaining.	Floor drying is underway. Heating on the circuits not concerned is shut down.  <ul style="list-style-type: none"> <li>▶ Wait for the number of days shown to change to 0</li> <li>▶ Set the parameter <b>SCREED DRYING</b> to <b>OFF</b></li> </ul>
<b>FL.DRY.C XX DAYS</b>		
<b>FL.DRY.B+C XX DAYS</b>		

### 7.3 Message history

The menu (#MESSAGE HISTORIC) is used to consult the last 10 messages displayed by the control panel.

1. Access the "After Sales" level: Hold down the  key until **#PARAMETERS** is displayed.
2. Select the menu (#MESSAGE HISTORIC).

-  Turn the rotary button to scroll through the menus or modify a value.
- ▶ Press the rotary button to access the menu selected or confirm a value modification.

 For a detailed explanation of menu browsing, refer to the chapter: "Browsing in the menus", page 31

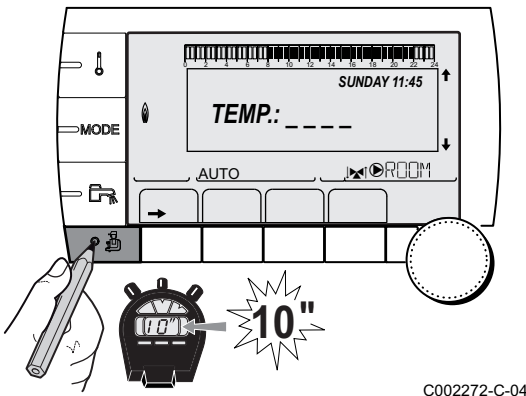

3. The list of the last 10 messages is displayed.

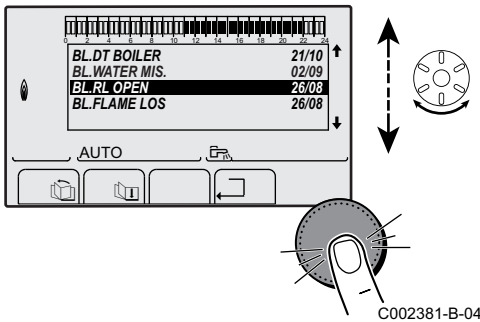

4. Select a message to consult the information pertaining to it.

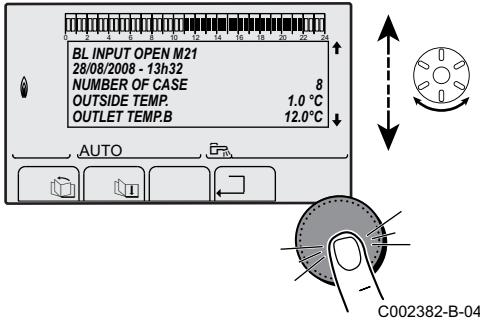





### 7.4 Faults

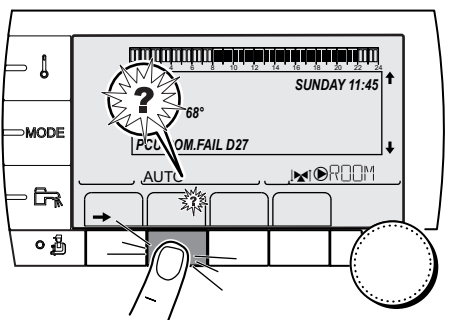

If a malfunction occurs, the iSense Pro DIN module flashes and displays an error message and a corresponding code.

1. Make a note of the code displayed.  
The code is important for the correct and rapid diagnosis of the type of failure and for any technical assistance that may be needed.
2. Press the ? key. Follow the instructions displayed to solve the problem.
3. Consult the meaning of the codes in the table below:





Code	Faults	Description	Checking / solution
D03 D04	OUTL S.B FAIL. OUTL S.C FAIL.	Circuit B flow sensor fault Circuit C flow sensor fault Remarks: The circuit pump is running. The 3-way valve motor on the circuit is no longer powered and can be adjusted manually.	Bad connection <ul style="list-style-type: none"> <li>▶ Check whether the sensor is connected:  See chapter: "Deletion of sensors from the memory in the PCB", page 58</li> <li>▶ Check the link and the connectors</li> <li>▶ Check that the sensor has been correctly fitted</li> </ul> Sensor fault <ul style="list-style-type: none"> <li>▶ Check the Ohmic value of the sensor</li> <li>▶ Replace the sensor if necessary</li> </ul>
D05	OUTSI.S.FAIL.	Outside temperature sensor fault Remarks: The boiler operates on <b>BOILER MAX</b> temperature. The valve setting is no longer ensured but monitoring the maximum temperature of the circuit after the valve is ensured. Valves may be manually operated. Reheating the domestic hot water remains ensured.	Bad connection <ul style="list-style-type: none"> <li>▶ Check whether the sensor is connected</li> <li>▶ Check the link and the connectors</li> <li>▶ Check that the sensor has been correctly fitted</li> </ul> Sensor fault <ul style="list-style-type: none"> <li>▶ Check the Ohmic value of the sensor</li> <li>▶ Replace the sensor if necessary</li> </ul>
D07	AUX.SENS.FAIL.	Auxiliary sensor fault	Bad connection <ul style="list-style-type: none"> <li>▶ Check whether the sensor is connected:  See chapter: "Deletion of sensors from the memory in the PCB", page 58</li> <li>▶ Check the link and the connectors</li> <li>▶ Check that the sensor has been correctly fitted</li> </ul> Sensor fault <ul style="list-style-type: none"> <li>▶ Check the Ohmic value of the sensor</li> <li>▶ Replace the sensor if necessary</li> </ul>
D09	DHW S.FAILURE	Domestic hot water sensor fault Remarks: Heating of domestic hot water is no longer ensured. The load pump operates. The load temperature of the dhw tank is the same as the boiler.	Bad connection <ul style="list-style-type: none"> <li>▶ Check whether the sensor is connected:  See chapter: "Deletion of sensors from the memory in the PCB", page 58</li> <li>▶ Check the link and the connectors</li> <li>▶ Check that the sensor has been correctly fitted</li> </ul> Sensor fault <ul style="list-style-type: none"> <li>▶ Check the Ohmic value of the sensor</li> <li>▶ Replace the sensor if necessary</li> </ul>
D12 D13	ROOM S.B FAIL. ROOM S.C FAIL.	B room temperature sensor fault C room temperature sensor fault Note: The circuit concerned operates without any influence from the room sensor.	Bad connection <ul style="list-style-type: none"> <li>▶ Check whether the sensor is connected:  See chapter: "Deletion of sensors from the memory in the PCB", page 58</li> <li>▶ Check the link and the connectors</li> <li>▶ Check that the sensor has been correctly fitted</li> </ul> Sensor fault <ul style="list-style-type: none"> <li>▶ Check the Ohmic value of the sensor</li> <li>▶ Replace the sensor if necessary</li> </ul>

Code	Faults	Description	Checking / solution
D14	MC COM.FAIL	Break in communication between the iSense Pro DIN module and the boiler radio module	<p>Bad connection</p> <ul style="list-style-type: none"> <li>▶ Check the link and the connectors</li> </ul> <p>Boiler module failure</p> <ul style="list-style-type: none"> <li>▶ Change the boiler module</li> </ul>
D15	ST.TANK S.FAIL	Storage tank sensor fault Note: The hot water storage tank reheating operation is no longer assured.	<p>Bad connection</p> <ul style="list-style-type: none"> <li>▶ Check whether the sensor is connected:  See chapter: "Deletion of sensors from the memory in the PCB", page 58</li> <li>▶ Check the link and the connectors</li> <li>▶ Check that the sensor has been correctly fitted</li> </ul> <p>Sensor fault</p> <ul style="list-style-type: none"> <li>▶ Check the Ohmic value of the sensor</li> <li>▶ Replace the sensor if necessary</li> </ul>
D16 D16	SWIM.P.B. S.FAIL SWIM.P.C. S.FAIL	Swimming pool sensor fault circuit B Swimming pool sensor fault circuit C Note: Pool reheating is independent of its temperature.	<p>Bad connection</p> <ul style="list-style-type: none"> <li>▶ Check whether the sensor is connected:  See chapter: "Deletion of sensors from the memory in the PCB", page 58</li> <li>▶ Check the link and the connectors</li> <li>▶ Check that the sensor has been correctly fitted</li> </ul> <p>Sensor fault</p> <ul style="list-style-type: none"> <li>▶ Check the Ohmic value of the sensor</li> <li>▶ Replace the sensor if necessary</li> </ul>
D17	DHW 2 S.FAIL	Sensor fault tank 2	<p>Bad connection</p> <ul style="list-style-type: none"> <li>▶ Check whether the sensor is connected:  See chapter: "Deletion of sensors from the memory in the PCB", page 58</li> <li>▶ Check the link and the connectors</li> <li>▶ Check that the sensor has been correctly fitted</li> </ul> <p>Sensor fault</p> <ul style="list-style-type: none"> <li>▶ Check the Ohmic value of the sensor</li> <li>▶ Replace the sensor if necessary</li> </ul>
D29	IOBL.3WV B DEF	Break in communication between the iSense Pro DIN module and the 3WV module	<p>The V3V module is switched off</p> <ul style="list-style-type: none"> <li>▶ Check that the 3WV module is powered up (Green LED LIT)</li> </ul> <p>The 3WV module and the iSense Pro DIN module are not connected to the same phase</p> <ul style="list-style-type: none"> <li>▶ Check that the 3WV module and the iSense Pro DIN module are on the same phase or that a phase coupler is installed</li> </ul> <p>The V3V module has been removed</p>
D30	IOBL.3WV C DEF	Break in communication between the iSense Pro DIN module and the 3WV module	<p>The V3V module is switched off</p> <ul style="list-style-type: none"> <li>▶ Check that the 3WV module is powered up (Green LED LIT)</li> </ul> <p>The 3WV module and the iSense Pro DIN module are not connected to the same phase</p> <ul style="list-style-type: none"> <li>▶ Check that the 3WV module and the iSense Pro DIN module are on the same phase or that a phase coupler is installed</li> </ul> <p>The V3V module has been removed</p>

Code	Faults	Description	Checking / solution
D31	COM.IOBL FAIL.	The IOBL function is no longer active	Problem on the iSense Pro DIN module <ul style="list-style-type: none"> <li>▶ If the IOBL function is not used, deactivate the IOBL function in the menu <b>#CONFIGURATION</b></li> <li>▶ If the IOBL function is used, change the iSense Pro DIN module and re-pair the peripherals (IOBL 3WV module, Interscenario switch)</li> </ul>
D50	DEF.COM.OTH	Break in communication between the iSense Pro DIN module and the boiler control panel.	<ul style="list-style-type: none"> <li>▶ Check the wiring between the iSense Pro DIN module and the control panel</li> <li>▶ Check that the parameter <b>DIN CONFIG</b> in the <b>#SYSTEM</b> menu is set to <b>OTH+3WV</b></li> </ul>
D51	DEF XX:SEE BOIL.	An error is displayed on the boiler control panel.	<ul style="list-style-type: none"> <li>▶ Refer to the boiler's installation and service manual.</li> </ul>

### 7.4.1. Deletion of sensors from the memory in the PCB

The configuration of the sensors is memorised by the PCB. If a sensor fault appears whilst the corresponding sensor is not connected or has been voluntarily removed, please delete the sensor from the PCB memory.

- ▶ Press key ? repeatedly until **Do you want to delete this sensor?** is displayed.
- ▶ Select **YES** by turning the rotary button and press to confirm.



A defective outside temperature sensor cannot be deleted from the SCU PCB.

### 7.4.2. Deleting the IOBL 3WV modules from the memory in the PCB

The configuration of the IOBL 3WV modules is memorised by the PCB. If a **IOBL.3WV B DEF** or **IOBL.3WV C DEF** fault appears after voluntary removal of a 3WV module, please delete the module from the PCB memory.

- ▶ Press key ? repeatedly until **Do you want to delete this module?** is displayed.
- ▶ Select **YES** by turning the rotary button and press to confirm.



You have the option of removing a IOBL 3WV module from the memory in the PCB:

- ▶ Go to the menu **#NETWORK** and select **REMOVE DEVICE**.

## 7.5 Failure history

The menu **#DEFAULT HISTORIC** is used to consult the last 10 faults displayed by the control panel.

1. Access the "After Sales" level: Hold down the  key until **#PARAMETERS** is displayed.
2. Select the menu **#DEFAULT HISTORIC**.



- ▶ Turn the rotary button to scroll through the menus or modify a value.
- ▶ Press the rotary button to access the menu selected or confirm a value modification.

 For a detailed explanation of menu browsing, refer to the chapter: "Browsing in the menus", page 31

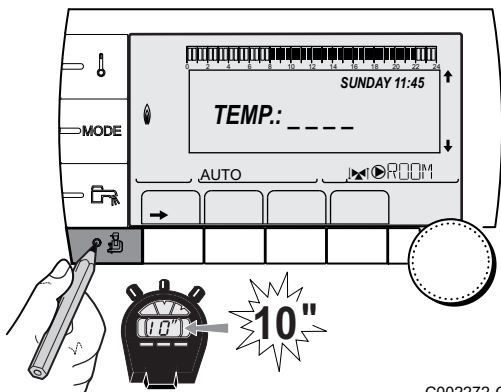

C002272-C-04

3. The list of the last 10 faults is displayed.

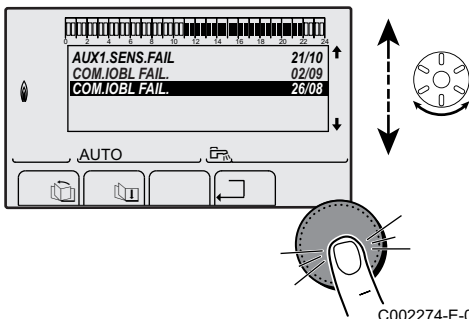

C002274-E-04

4. Select a fault to consult the information pertaining to it.

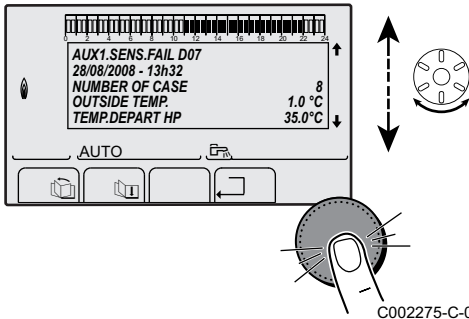

C002275-C-04

## 7.6 Parameter and input/output check (mode tests)

Use the following menus to target the cause of a malfunction.

1. Access the "After Sales" level: Hold down the  key until **#PARAMETERS** is displayed.
2. Check the following parameters:



- ▶ Turn the rotary button to scroll through the menus or modify a value.
- ▶ Press the rotary button to access the menu selected or confirm a value modification.

 For a detailed explanation of menu browsing, refer to the chapter: "Browsing in the menus", page 31

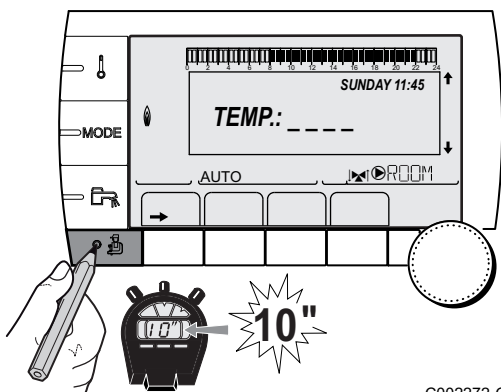

C002272-C-04

After Sales level - #PARAMETERS menu	
Parameter	Description
PERMUT	Master boiler active
STAGE	Number of boilers requesting heating
NB.CASC.:	Number of boilers recognised in the cascade
NB. VM:	Number of DIEMATIC VM control systems recognised in the cascade
MEAN OUTSIDE T	Average outside temperature
CALC.T. BOILER	Temperature calculated by the boiler
BOILER. T. <sup>(1)</sup>	Measurement of the boiler flow sensor
CALCULATED T. B <sup>(2)</sup>	Calculated temperature for circuit B
CALCULATED T. C <sup>(2)</sup>	Calculated temperature for circuit C
OUTLET TEMP. B <sup>(1)</sup> <sup>(2)</sup>	Temperature of the flow water in circuit B
OUTLET TEMP. C <sup>(1)</sup> <sup>(2)</sup>	Temperature of the flow water in circuit C
OUTSIDE TEMP. <sup>(1)</sup>	Outside temperature
ROOMTEMP. B <sup>(1)</sup> <sup>(2)</sup>	Room temperature of circuit B
ROOMTEMP. C <sup>(1)</sup> <sup>(2)</sup>	Room temperature of circuit C
WATER TEMP. <sup>(1)</sup> <sup>(2)</sup>	Water temperature in the DHW tank
IN 0-10V <sup>(1)</sup> <sup>(2)</sup>	Voltage at input 0-10 V
STOR.TANK.TEMP <sup>(1)</sup>	Water temperature in the storage tank
SYSTEM TEMP. <sup>(1)</sup> <sup>(2)</sup>	Temperature of the system flow water if multi-generator
T.DHW BOTTOM <sup>(1)</sup> <sup>(2)</sup>	Water temperature in the bottom of the DHW tank
TEMP.TANK AUX <sup>(1)</sup> <sup>(2)</sup>	Water temperature in the second DHW tank connected to the AUX circuit
KNOB B <sup>(2)</sup>	Position of temperature setting button on room sensor B
KNOB C <sup>(2)</sup>	Position of temperature setting button on room sensor C
OFFSET ADAP B <sup>(2)</sup>	Parallel trigger calculated for circuit B
OFFSET ADAP C <sup>(2)</sup>	Parallel trigger calculated for circuit C
<sup>(1)</sup> The parameter can be displayed by pressing key $\uparrow$ .	
<sup>(2)</sup> The parameter is only displayed for the options, circuits or sensors actually connected	

After Sales level - #TEST OUTPUTS menu		
Parameter	Adjustment range	Description
P. CIRC. B <sup>(1)</sup>	ON / NO	Stop/start pump circuit B
P. CIRC. C <sup>(2)</sup>	ON / NO	Stop/start pump circuit C
HW. PUMP <sup>(2)</sup>	ON / NO	Stop/start domestic hot water pump
AUX.CIRC.	ON / NO	On/Off auxiliary outlet
3WV B <sup>(2)</sup>	REST	No command
	OPEN:	Opening 3-way valve circuit B
	CLOSE:	Closure 3-way valve circuit B
3WV C <sup>(2)</sup>	REST	No command
	OPEN:	Opening 3-way valve circuit C
	CLOSE:	Closure 3-way valve circuit C
<sup>(1)</sup> The parameter is only displayed for the options, circuits or sensors actually connected		

After Sales level - #TEST INPUTS menu		
Parameter	Status OK	Description
PHONE REM. <sup>(1)</sup>	0 / 1	Status of the telephone inlet
FAILURE	ON / NO	Presence of an error
R.CTRL B <sup>(1)</sup>	ON	Presence of a remote control B
	NO	No remote control B
R.CTRL C <sup>(1)</sup>	ON	Presence of a remote control C
	NO	No remote control C

(1) The parameter is only displayed if the parameter **IN 0-10V** is set to **OFF**

After Sales level - #INFORMATION menu <sup>(1)</sup>		
Parameter	Adjustment range	Description
S/N SCU		Serial no. of the iSense Pro DIN control panel
CTRL		Control version
ID MC IOBL		Identifying number of the IOBL boiler module
IOBL.VERSION		IOBL version of the SCU PCB
MC.VERSION <sup>(2)</sup>		Version of the boiler radio module programme
CALIBRA.CLOCK		Clock calibration

(1) The menu is displayed only if the **INSTALLATION** parameter is set to **EXTENDED**  
(2) The parameter is only displayed for the options, circuits or sensors actually connected

After Sales level - #CONFIGURATION menu		
Parameter	Adjustment range	Description
MODE:	MONO/ ALL.CIRC.	To chose if the exemption made for one remote control applies to a single circuit ( <b>MONO</b> ) or if it must be transmitted to a group of circuits ( <b>ALL CIRC</b> )
IOBL	OFF/ON	Activation of the IOBL function



Broag Ltd.  
Remeha House  
Molly Millars Lane  
RG41 2QP WOKINGHAM,  
Berks.

Tel: +44 118 9783434  
Fax: +44 118 9786977  
Internet: uk.remeha.com  
E-mail: boilers@broag-remeha.com



© Copyright

All technical and technological information contained in these technical instructions, as well as any drawings and technical descriptions supplied, remain our property and shall not be multiplied without our prior consent in writing.

12/04/2011 - 0451129481



300025649-001-B

The Remeha logo is located at the bottom right of the page. It features a stylized 'R' inside a square, followed by the word 'remeha' in a bold, lowercase sans-serif font. The logo is set against a black background with a yellow border above and below it.

**remeha**